

# User Manual

Z BOX-P LIQUID COOLING CONTAINER



## P 3400-2H

Product Model:  
P3440L2H-B

Dedicated to Being a Global Force in Transforming Energy Structures

## IMPORTANT NOTICE



### CAUTION

READ THIS MANUAL BEFORE PERFORMING ANY INSTALLATION ACTION!  
IF YOU HAVE ANY UNCERTAINTY REGARDING THE CONTENT OF THIS  
MANUAL, PLEASE CONTACT ZOE FOR ADVICE OR CLARIFICATION.



### IMPORTANT

KEEP THIS MANUAL IN A SECURE PLACE FOR FUTURE REFERENCES!



### CAUTION

THIS DOCUMENTATION ALONG WITH INFORMATION INSIDE IS THE  
PROPERTY OF Shanghai ZOE Energy Storage Technology Co., Ltd.  
COPYRIGHT © Shanghai ZOE Energy Storage Technology Co., Ltd.  
ALL RIGHT RESERVED.

THIS DOCUMENTATION IS FOR THE SOLE PURPOSE OF THE INSTALLATION  
OF ZOE BESS PRODUCTS ANY PART OF THIS PUBLICATION SHALL NOT BE  
USED FOR ANY OTHER PURPOSE, AND SHALL NOT BE COPIED,  
REPRODUCED, DISCLOSED, TRANSMITTED, STORED IN A RETRIEVAL  
SYSTEM, OR TRANSLATED INTO ANY HUMAN OR DIGITAL LANGUAGE, IN  
ANY FORM, BY ANY MEANS, IN WHOLE OR IN PART WITHOUT PRIOR  
WRITTEN CONSENT FROM Shanghai ZOE Energy Storage Technology  
Co., Ltd.



### IMPORTANT

ALTHOUGH ZOE HAS MADE ITS BEST EFFORT TO ENSURE THE ACCURACY  
OF THIS DOCUMENTATION, Shanghai ZOE Energy Storage Technology  
Co., Ltd. TAKES NO  
RESPONSIBILITY FOR THE ERRORS/TYPOS THAT MAY APPEAR HEREIN.  
THIS DOCUMENTATION IS SUBJECT TO CHANGES WITHOUT PRIOR  
NOTICE.

# TABLE OF CONTENTS

IMPORTANT NOTICE .....	3
TABLE OF CONTENTS .....	4
LIST OF FIGURES .....	7
LIST OF TABLES .....	9
1 ACRONYMS AND DEFINITIONS.....	10
2 ABOUT THIS MANUAL.....	12
2.1 APPLICABLE PRODUCT.....	12
2.2 TARGET GROUP .....	12
2.3 LEVELS OF SAFETY INSTRUCTIONS .....	13
2.4 SYMBOLS ON THE PRODUCT .....	14
3 SAFETY GUIDELINES .....	17
3.1 GENERAL PRECAUTIONS.....	17
3.2 PERSONNEL REQUIREMENTS .....	21
3.3 ELECTRICAL SAFETY .....	22
3.3.1 GROUNDING REQUIREMENTS .....	22
3.3.2 GENERAL REQUIREMENTS .....	22
3.3.3 DC OPERATION .....	22
3.3.4 WIRING REQUIREMENTS .....	23
3.3.5 ANTI-STATIC REQUIREMENTS .....	23
3.4 FIRST-AID MEASURES .....	23
3.4.1 HAZARD AND TOXICITY INSTRUCTIONS .....	23
3.4.2 FIRST-AID MEASURES FOR BATTERY ABNORMALITIES .....	24
3.4.3 FIRST-AID MEASURES FOR FIRE.....	24
3.4.4 FIRST-AID MEASURES FOR BATTERY DROP .....	25
3.5 BATTERY RECYCLING TREATMENT .....	26
3.6 STORAGE REQUIREMENTS.....	26
3.7 HANDLING GUIDELINES.....	28
3.8 PERSONAL PROTECTIVE EQUIPMENT .....	30
4 SYSTEM OVERVIEW.....	33
4.1 SYSTEM DESIGN.....	33
4.1.1 PRODUCT SERIES.....	33

4.1.2	SYSTEM DESCRIPTION .....	33
4.1.3	SPECIFICATION .....	34
5	MAIN SYSTEM EQUIPMENT.....	35
5.1	BATTERY SYSTEM.....	35
5.1.1	BATTERY CELL .....	35
5.1.2	BATTERY MODULE .....	35
5.1.3	BATTERY RACK .....	36
5.1.4	BATTERY MANAGEMENT SYSTEM.....	36
5.2	GOLDEN SHIELD CONTROLLER .....	38
5.2.1	FEATURES AND FUNCTIONS .....	38
5.2.2	COMMUNICATION TOPOLOGY.....	38
5.3	THERMAL MANAGEMENT SYSTEM.....	39
5.3.1	COOLING CONCEPT .....	39
5.3.2	HVAC INTRODUCTION .....	40
5.3.3	HVAC INTERFACE .....	42
5.4	FIRE SUPPRESSION SYSTEM .....	46
5.4.1	FIRE CONTROL FLOW CHART .....	46
5.4.2	FIRE SUPPRESSION SYSTEM .....	48
5.4.3	FIRE DETECTION AND ALARM SYSTEM .....	49
5.4.4	WATER SPRINKLER SYSTEM .....	50
6	INSTALLATION .....	52
6.1	MAIN TOOLS AND COMPONENTS FOR INSTALLATION.....	52
6.2	PREPARATION FOR INSTALLATION .....	54
6.2.1	INSTALLATION ENVIRONMENT REQUIREMENTS.....	54
6.2.2	CHECK BEFORE INSTALLATION .....	54
6.2.3	INSTALLATION SPACE.....	55
6.2.4	FOUNDATION REFERENCE .....	57
6.3	PRODUCT HANDLING .....	59
6.4	INSTALLATION STEPS .....	60
6.4.1	DEVICE FIXATION .....	60
6.4.2	DEVICE GROUNDING.....	61
6.4.3	WATER FIRE SUPPRESSION PIPE CONNECTION .....	62
7	ELECTRICAL CONNECTION.....	64
7.1	PREPARATION FOR INSTALLATION .....	64
7.2	SYSTEM ELECTRICAL CONNECTION.....	65
7.2.1	AUXILIARY POWER CONNECTION INTERFACE.....	66

7.2.2	RESERVED PCS DRY CONTACT INTERFACE.....	66
7.2.3	PCS POWER CABLE INTERFACE.....	67
7.3	DC SWITCHGEAR AND PACK DESCRIPTION.....	68
8	COMMISSIONING .....	71
8.1	PRE-COMMISSIONING OF BCP .....	71
8.1.1	CABLE CONNECTION CONFIRMATION.....	71
8.1.2	MCB .....	71
8.2	POWER-ON PROCEDURES .....	72
8.2.1	POWERING ON THE AUXILIARY POWER SUPPLY .....	72
8.2.2	POWERING ON AND OFF THE HVDC .....	74
8.3	POWER-OFF PROCEDURES .....	76
8.3.1	POWERING OFF THE AUXILIARY POWER SUPPLY .....	76
9	OPERATION.....	78
9.1	SYSTEM OPERATION.....	78
9.1.1	TEMPERATURE CHARACTERISTICS .....	78
9.1.2	CABLE CONNECTION CONFIRMATION.....	78
10	MAINTENANCE.....	79
10.1	PRECAUTIONS .....	79
10.2	BATTERY OPERATING TERMS AND OPERATING INSTRUCTIONS.....	80
10.2.1	TERMS EXPLANATION .....	80
10.2.2	OPERATING INSTRUCTIONS.....	80
10.3	OPERATING METHOD OF BATTERY MAINTENANCE .....	81
10.4	VISUAL INSPECTION .....	82
10.5	MECHANICAL INSPECTION.....	83
10.6	ELECTRICAL INSPECTION .....	84
10.7	CONTROL INSPECTION.....	85
10.8	SAFETY INSPECTION .....	85
11	COMMON FAULTS AND TROUBLESHOOTING .....	86
12	AFTER-SALES SERVICE.....	88
13	CONTACT .....	89

## LIST OF FIGURES

Figure 2-1: Rendering of the Product.....	12
Figure 3-2: Safe gear for installation.....	31
Figure 4-1: Appearance .....	33
Figure 5-1: SBMS interface to Ethernet Switch .....	37
Figure 5-2: Architecture of the BMS .....	37
Figure 5-3: Rendering of Golden Shield.....	38
Figure 5-4: Communication topology with Golden Shield .....	39
Figure 5-5: Working principle of Liquid Cooling.....	40
Figure 5-6: Unit menu structure diagram.....	43
Figure 5-7: Control system homepage interface .....	44
Figure 5-8: Control interface icons .....	44
Figure 5-9: System start-up.....	45
Figure 5-10: System shutdown.....	45
Figure 5-11: Environment Status interface .....	46
Figure 5-12: Run Status interface .....	46
Figure 5-13: Fire control flow chart .....	47
Figure 5-14: Aerosol automatic fire extinguisher (for reference).....	49
Figure 5-15: Smoker and Temperature Detector (for reference only) .....	49
Figure 5-16: Flammable Gas Detector (for reference only) .....	50
Figure 5-17: Water Sprinkler Nozzle (for reference only).....	50
Figure 5-18: Water Sprinkler System (for reference only).....	51
Figure 6-1: Installation space requirements for single container (unit: mm) .....	56
Figure 6-2: Installation space requirements for containers (unit: mm) .....	56
Figure 6-3: Installation space requirements for single container (unit: mm) .....	57
Figure 6-4: Installation space requirements for containers (unit: mm) .....	57
Figure 6-5: Foundation Reference Front View (unit: mm) .....	57
Figure 6-6: Foundation Reference Left View (unit: mm) .....	58
Figure 6-7: Foundation Reference Top View (unit: mm) .....	58
Figure 6-8: Crane lifting .....	60
Figure 6-9: Center of gravity (for reference only) .....	60
Figure 6-10: Install L-brackets .....	61
Figure 6-11: Install grounding cables. ....	62
Figure 6-12: Water fire suppression pipe coupling.....	63

Figure 7-1: BCP auxiliary power supply copper bar.....66

Figure 7-2: PCS reserved dry contact for emergency stop. ....67

Figure 7-3: The BCP copper bars to PCS.....67

Figure 7-4: BCP wiring .....68

Figure 7-5: DC switchgear interface .....68

Figure 7-6: PACK interface .....69

Figure 8-1: Auxiliary connection (for reference only) .....72

Figure 8-2: GS-web operation and maintenance mode switch .....73

Figure 8-3: Energy storage system information overview.....74

Figure 8-4: RACK information interface .....75

Figure 8-5: HVAC and other auxiliary equipment information .....75

Figure 8-6: BMS real-time running information .....76

Figure 8-7: BMS1 , BMS2 switchover .....76

Figure 8-8: Auxiliary connection (for reference only) .....77



## LIST OF TABLES

Table 4-1: Product series .....	33
Table 4-2: Introduction .....	33
Table 4-3: Specification .....	34
Table 5-1: Specification of the Battery cell .....	35
Table 5-2: Specification of Module .....	35
Table 5-3: Specification of Battery Rack .....	36
Table 5-4: BMS Functionality .....	37
Table 5-5: Specification of HVAC.....	41
Table 5-6: Device list.....	48
Table 6-1: Tools for system installation.....	52
Table 7-1: Tools for electrical connection .....	64
Table 7-2: Interface Connectors of DC Switchgear .....	68
Table 7-3: Interface Connectors of PACK .....	70
Table 8-1: Check list.....	71
Table 8-2: MCB0~MCB12 .....	71
Table 10-1: Terms Explanation.....	80
Table 10-2: Operating Instructions.....	80
Table 10-3: Operating Method of Battery Maintenance.....	81
Table 10-4: Visual Inspection .....	82
Table 10-5: Mechanical Inspection.....	83
Table 10-6: Electrical Inspection .....	84
Table 10-7: Control Inspection .....	85
Table 10-8: Safety Inspection .....	85
Table 11-1: Common faults and troubleshooting .....	86

# 1 ACRONYMS AND DEFINITIONS

1	AC	Alternating Current
2	Ah	Amp-hour
3	BCP	Battery Connection Panel
4	BESS	Battery Energy Storage System
5	BMS	Battery Management System
6	BOL	Beginning of Life
7	BOP	Balance of Plant
8	BOS	Balance of System
9	BSPU	Battery Safety and Protection Unit
10	EMS	Energy Management System
11	EOL	End of Life
12	ESS	Energy Storage System
13	DC	Direct Current
14	FSS	Fire Suppression System
15	HMI	Human Machine Interface
16	HV	High Voltage
17	HVAC	Heating & Ventilation and HVAC
18	IP	Ingress Protection
19	kV	Kilovolt
20	kW	Kilowatt
21	MV	Medium Voltage
22	MW	Megawatt
23	MWh	Megawatt-hour
24	MVA	Mega Volt-Amps
25	MVAr	Mega Volt Amps (reactive)
26	NMC	NiMnCo
27	OSD	Overcharge Safety Device
28	O&M	Operation and Maintenance
29	PCS	Power Conversion System
30	PPA	Power Purchase Agreement

31	PPE	Personal Protective Equipment
32	RMU	Ring Main Unit
33	RTU	Remote Terminal Unit
34	SCADA	Supervisory Control and Data Acquisition
35	SOC	State of Charge
36	SOH	State of Health
37	SPDs	Surge Protection Devices
38	ZOE	Shanghai ZOE Energy Storage Technology Co., Ltd.
39	TCP	Transmission Control Protocol
40	UPS	Uninterruptable Power Supply

## 2 ABOUT THIS MANUAL

### 2.1 APPLICABLE PRODUCT

This document mainly describes the installation, electrical connection, debugging, maintenance and troubleshooting methods of the following models of battery containers ("Product").

➤ P3440L2H-B

Before installing or using the product, read this document carefully to obtain the safety information and be familiar with the functions and features of the product. If you have any questions about the contents of this manual, please contact ZOE for advice or clarification.



Figure 2-1: Rendering of the Product

### 2.2 TARGET GROUP

This manual is intended for:

- Installation and maintenance personnel
- Users

## 2.3 LEVELS OF SAFETY INSTRUCTIONS

To ensure personal and property safety in using the system or to use the system efficiently, this manual provides relevant instructions that are highlighted by corresponding symbols. Read the following symbols carefully, as they indicate levels of safety warnings and are used everywhere in this manual.

To ensure the safety of personnel and property, please carefully read all safety instructions in this document before the installation.

	<b>DANGER</b> FAIL TO FOLLOW THE INSTRUCTION WITH THIS SYMBOL MAY RESULT IN A FATAL ACCIDENT, SEVERE INJURY, EVEN DEATH!
---	---

	<b>WARNING</b> INDICATES A HAZARDOUS SITUATION THAT, IF NOT AVOIDED, COULD RESULT IN INJURY OR DEATH.
--	--

	<b>CAUTION</b> INDICATES A HAZARDOUS SITUATION THAT, IF NOT AVOIDED, COULD RESULT IN MINOR INJURY OR DAMAGE TO THE EQUIPMENT.
---	--

	<b>IMPORTANT</b> INFORMATION WHICH CONSIDERED IMPORTANT BUT NOT HAZARD-RELATED. FAIL TO FOLLOW THE INSTRUCTION WITH THIS SYMBOL MAY RESULT IN EQUIPMENT DAMAGE!
---	--

	<b>IMPORTANT</b> INDICATES AN IMPORTANT STEP OR TIP THAT LEADS TO BEST RESULTS, BUT IS NOT SAFETY OR DAMAGE RELATED.
---	---

## 2.4 SYMBOLS ON THE PRODUCT



HAZARDOUS VOLTAGE, RISK OF ELECTRIC SHOCK OR BURN.  
AUTHORIZED PERSONNEL ONLY.



OPEN THE DOOR.



CLOSE THE DOOR.



GROUNDING.



DANGER, BE CAREFUL WHEN HANDLING THE BATTERIES.



RECHARGEABLE BATTERIES, CANNOT DISPOSE OF IN THE  
HOUSEHOLD WASTE.



DO NOT DAMAGE THE BATTERIES IN SUCH A WAY AS DROP,  
DEFORM, IMPACT, CUT, OR SPEARING OBJECT.



NO SMOKING, NO OPEN FLAME, EMBERS, OR SPARKS NEARBY THE BATTERY, TO AVOID RISK OF FIRE OR EXPLOSION.



KEEP OUT OF REACH OF YOUNG CHILDREN PETS, OR ANIMALS.



HEAVYWEIGHT, SINGLE-PERSON LIFT COULD CAUSE INJURY. USE ASSISTANCE WHEN MOVING OR LIFTING.



ELECTROLYTE IS HIGHLY CORROSIVE.



METAL PARTS OF THE BATTERY CELL ARE ALWAYS LIVE. NEVER PLACE FOREIGN OBJECTS OR TOOLS ON THE BATTERY.



OBSERVE INSTALLATION AND OPERATION INSTRUCTIONS IN THE MANUALS BEFORE WORKING ON THE BATTERIES.



WEAR EYE PROTECTION AND PROTECTIVE CLOTHING WHEN WORKING WITH BATTERIES. OBSERVE ACCIDENT-PREVENTION REGULATIONS.



WEAR PROTECTIVE GLOVES AND CLOTHING WHEN WORKING WITH BATTERIES.



PREPARE FIRST-AID BEFORE WORKING WITH BATTERIES.



WHEN ELECTROLYTES LEAK OUT, AVOID CONTACTING WITH EYES, SKIN, OR CLOTHES. IN EVENTS OF ACCIDENTS, FLUSH WITH WATER AND GET MEDICAL HELP IMMEDIATELY.



RECYCLABLE.



## 3 SAFETY GUIDELINES



### 3.1 GENERAL PRECAUTIONS

When installing, operating, and maintaining the equipment, read this manual and follow the labels on the equipment and all safety precautions in this manual.

The "Danger", "Warning", "Caution" and "Important" in this manual do not represent all the safety precautions to be followed, but only serve as a supplement to the safety precautions. ZOE is not responsible for any breach of safe operation requirements or safety standards for design, manufacture, and use of the equipment.

The product should be used in an environment that meets the design requirements. Otherwise, the equipment may fail, and the resulting equipment function abnormalities, component damage, personal safety accidents, and property losses are not covered by the quality guarantee.

Comply with local laws and regulations when installing, operating, and maintaining the equipment. The safety precautions in this manual only serve as a supplement to local laws and regulations.

#### **ZOE is not responsible for any of the following circumstances:**

- Do not operate under the operating conditions described in this manual.
- The installation and operating environment dose not conform to international, state or regional standards.
- Disassemble or modify the product or modify the software code without authorization.
- Do not follow the operation instructions and safety warnings written on the product and in the manual.
- Equipment damage caused by abnormal natural environment (earthquake, fire, storm, flood, debris flow, etc.)
- Damage caused by storage conditions that do not meet product

documentation requirements.

- Hardware or data damage caused by negligence, improper operation or intentional destruction of customers.

	<b>DANGER</b>
	DO NOT INSTALL, USE, OR OPERATE OUTDOOR DEVICES AND CABLES (INCLUDING BUT NOT LIMITED TO HANDLING DEVICES, OPERATING DEVICES AND CABLES, PLUGGING AND UNPLUGGING SIGNAL PORTS CONNECTED TO THE OUTDOORS, WORKING AT HEIGHTS, AND OUTDOOR INSTALLATION) IN SEVERE WEATHER SUCH AS LIGHTNING, RAIN, SNOW, STRONG BREEZE OR WIND OF HIGHER FORCE ON BEAUFORT WIND SCALE.

	<b>DANGER</b>
	OBSERVE THE REQUIREMENTS OF THIS MANUAL, USE THE CORRECT TOOLS, AND MASTER THE CORRECT METHODS OF USING THE TOOLS.

	<b>DANGER</b>
	MEASURE THE VOLTAGE AT THE CONTACT POINT BEFORE TOUCHING ANY CONDUCTOR SURFACE OR TERMINAL TO ENSURE THAT THERE IS NO DANGER OF ELECTRIC SHOCK.

	<b>DANGER</b>
	PAINT SCRATCH IN THE PROCESS OF EQUIPMENT TRANSPORTATION AND INSTALLATION MUST BE REPAIRED IN TIME, AND IT IS STRICTLY FORBIDDEN TO EXPOSE THE SCRATCHED PART TO THE OUTDOOR ENVIRONMENT FOR A LONG TIME.

	<b>DANGER</b>
	DO NOT CHANGE THE STRUCTURE, INSTALLATION ORDER, ETC. OF THE EQUIPMENT WITHOUT AUTHORIZATION AND PERMISSION UNDER ANY CIRCUMSTANCES

	<b>DANGER</b>
	IN CASE OF FIRE, EVACUATE THE BUILDING OR EQUIPMENT AREA AND PRESS THE FIRE BELL OR CALL THE FIRE ALARM. UNDER NO CIRCUMSTANCES SHOULD YOU RE-ENTER THE BURNING BUILDING.



**DANGER**

PLEASE BE AWARE THAT THE BATTERIES PRESENT A RISK OF ELECTRICAL SHOCK INCLUDING A HUGE SHORT-CIRCUIT CURRENT.



**DANGER**

ARC FLASH HAZARD IS ASSOCIATED WITH BATTERIES. THERE IS A SERIOUS RISK OF ARC FLASH RELATING TO ANY EQUIPMENT MODIFICATION. SERIOUS INJURIES CAN OCCUR IN ARC FLASH INCIDENTS.



**WARNING**

FIRE MAY OCCUR UNDER CERTAIN FAULT CONDITIONS.



**WARNING**

REMOVE WATCHES, RINGS, OR OTHER METAL OBJECTS.  
WEAR PROPER PPE IN ACCORDANCE WITH LOCAL CODES AND REGULATIONS.



**WARNING**

USE TOOLS WITH INSULATED HANDLES TO AVOID ACCIDENTAL SHORT-CIRCUIT.  
DO NOT PUT TOOLS OR ANY METAL PARTS ON THE TOP OF THE BATTERIES.



**WARNING**

DO NOT OPEN OR VANDALIZE THE BATTERIES.



**WARNING**

BATTERIES SHALL BE DISPOSED OF ACCORDING TO THE ZOE RECYCLING POLICY, DISPOSE OF THE BATTERIES IN A FIRE COULD CAUSE AN EXPLOSION.



**WARNING**

SHARP POINTS AND PINCH POINTS ARE PRESENT ON MOST SYSTEM COMPONENTS. BE AWARE OF THE SERIOUS RISK OF INJURY WHILE WORKING AROUND EQUIPMENT BATTERIES.



**CAUTION**

COMPONENTS IN THE BATTERY SYSTEM CAN BE DAMAGED BY ELECTROSTATIC DISCHARGE. BE SURE TO WEAR A GROUNDED ANTI-STATIC WRIST STRAP AND TO DISCHARGE STATIC ELECTRICITY BY TOUCHING A GROUNDED SURFACE NEAR THE EQUIPMENT BEFORE YOU TOUCH ANY SYSTEM COMPONENTS.



**CAUTION**

DAMAGE, MISHANDLING, OR EXPOSURE TO CONDITIONS BEYOND THOSE RECOMMENDED BY ZOE COULD RESULT IN LEAKAGE OF FLAMMABLE GAS, WITH CONSEQUENT HAZARDOUS SITUATIONS ARISING.



**CAUTION**

WHEN CARRYING OUT TRANSPORTATION, TURNOVER, INSTALLATION, WIRING AND MAINTENANCE AND OTHER OPERATIONS, IT MUST MEET THE LAWS AND REGULATIONS AND RELEVANT STANDARDS OF THE COUNTRY OR REGION WHERE IT IS LOCATED.



**CAUTION**

IT IS NECESSARY TO OBTAIN THE PERMISSION OF THE POWER DEPARTMENT OF THE COUNTRY OR REGION WHERE IT IS LOCATED TO WORK ON THE GRID.



**CAUTION**

BE FAMILIAR WITH THE COMPOSITION OF THE ENTIRE ENERGY STORAGE SYSTEM, WORKING PRINCIPLE, AND THE RELEVANT STANDARDS OF THE COUNTRY/REGION WHERE THE PROJECT IS LOCATED.

	IMPORTANT
	<p>REVERSE ENGINEERING, DECOMPILING, DISASSEMBLING, ADAPTING, IMPLANTING OR OTHER DERIVATIVE OPERATIONS ON THE DEVICE SOFTWARE ARE PROHIBITED. RESEARCH ON THE INTERNAL IMPLEMENTATION OF THE DEVICE, OBTAINING THE SOURCE CODE OF THE DEVICE SOFTWARE, STEALING INTELLECTUAL PROPERTY, ETC., AND DISCLOSURE OF THE PERFORMANCE TEST RESULTS OF ANY DEVICE SOFTWARE ARE PROHIBITED.</p>

## 3.2 PERSONNEL REQUIREMENTS

- Personnel responsible for the installation and maintenance of ZOE equipment must be trained to understand safety precautions and correct operation methods.
- Only qualified professionals or trained personnel are allowed to install, operate, and maintain the equipment.
- Only qualified professionals are allowed to remove safety facilities and repair equipment.
- Personnel who operate the equipment, including operators, trained personnel, and professionals, must have local and state-required special operation qualifications, such as high voltage operation, height climbing, and special equipment operation qualifications.
- Replace equipment or components (including software) only by professionals or authorized personnel.

	CAUTION
	<p>PROFESSIONAL PERSONNEL: PERSONNEL WITH TRAINING OR EXPERIENCE IN OPERATING DEVICES AND KNOW THE POTENTIAL SOURCES AND LEVELS OF HAZARDS DURING DEVICE INSTALLATION, OPERATION, AND MAINTENANCE.</p> <p>TRAINED PERSONNEL: PERSONNEL WITH APPROPRIATE TECHNICAL TRAINING AND NECESSARY EXPERIENCE. BEING AWARE OF THE DANGER THAT MAY BE POSED TO HIM WHILE PERFORMING AN OPERATION AND MINIMIZE THE RISK TO HIMSELF OR OTHER PERSONNEL.</p> <p>OPERATING PERSONNEL: OTHER THAN TRAINED PERSONNEL AND PROFESSIONAL PERSONNEL WHO MAY COME INTO CONTACT WITH THE EQUIPMENT.</p>

### 3.3 ELECTRICAL SAFETY

#### 3.3.1 GROUNDING REQUIREMENTS

- When installing a device that needs to be grounded, install the protective grounding cable first. When removing a device, remove the protective grounding cable at the end.
- Do not damage the grounding conductor.
- Do not operate the device without a grounding conductor installed.
- The device should be permanently connected to protective ground. Before operating the device, check the electrical connections of the device to ensure that the device is reliably grounded.

#### 3.3.2 GENERAL REQUIREMENTS

	WARNING
	BEFORE ELECTRICAL CONNECTION, ENSURE THAT THE DEVICE IS NOT DAMAGED; OTHERWISE, ELECTRIC SHOCK OR FIRE MAY OCCUR.

- All electrical connections must meet national/regional electrical standards.
- You must obtain permission from the electricity authority of the country/region to connect to the grid.
- Cables prepared by customers must meet local laws and regulations.
- When performing high voltage operations, use special insulation tools.

#### 3.3.3 DC OPERATION

	WARNING
	DO NOT INSTALL OR REMOVE POWER CABLES WHEN POWER IS ON. TRANSIENT CONTACT BETWEEN THE CORE OF A POWER CABLE AND THE CONDUCTOR GENERATES ELECTRIC ARCS OR SPARKS, WHICH MAY CAUSE FIRE OR PERSONAL INJURY.

- Before electrical connection of the device, if live parts may be encountered, disconnect the corresponding disconnecting device at the front stage of the device.

- Before connecting a power cable, ensure that the label on the power cable is correct.
- If the device has multiple inputs, disconnect all inputs and perform operations on the device only after the device is completely powered off.

### 3.3.4 WIRING REQUIREMENTS

- The insulation layer may be aged or damaged if cables are used in a high temperature environment. Keep at least 50mm away from the heating device or heat source area.
- Cables of the same type must be bound together. Cables of different types must be routed at least 30mm apart. Do not intertwine or cross cables.
- Cables must be securely connected, properly insulated, and of appropriate specifications.
- Protect the pipe or cable holes from sharp edges and burrs.

### 3.3.5 ANTI-STATIC REQUIREMENTS

	CAUTION
	<p>THE STATIC ELECTRICITY GENERATED BY HUMAN BODIES MAY DAMAGE THE ELECTROSTATIC SENSITIVE COMPONENTS ON BOARDS, SUCH AS THE LARGE-SCALE INTEGRATED CIRCUIT (LSI).</p> <p>WEAR ESD GLOVES WHEN TOUCHING THE PCB BOARD. DO NOT WEAR CLOTHES PRONE TO STATIC ELECTRICITY.</p>

## 3.4 FIRST-AID MEASURES

### 3.4.1 HAZARD AND TOXICITY INSTRUCTIONS

	DANGER
	<p>HAZARD: CONTACT OF BATTERY MODULE TERMINALS WITH OTHER METALS MAY CAUSE HEAT OR ELECTROLYTE LEAKAGE. ELECTROLYTE IS FLAMMABLE, AND IF THE ELECTROLYTE LEAKS, REMOVE THE BATTERY MODULE FROM THE FIRE IMMEDIATELY.</p>

	DANGER
	<p>TOXICITY: STEAM FROM BURNING BATTERIES MAY IRRITATE EYES, SKIN AND THROAT.</p>

### 3.4.2 FIRST-AID MEASURES FOR BATTERY ABNORMALITIES

	DANGER
	<p>WHEN THERE IS ELECTROLYTE LEAKAGE OR ABNORMAL SMELL, AVOID CONTACT WITH THE LEAKING LIQUID OR GAS. NON- PROFESSIONALS SHOULD KEEP AWAY AND CONTACT PROFESSIONALS IMMEDIATELY. PROFESSIONALS SHOULD WEAR SAFETY GOGGLES, RUBBER GLOVES, GAS MASKS, AND PROTECTIVE CLOTHING TO PROTECT THEMSELVES FROM ELECTROLYTE OVERFLOW.</p>

	DANGER
	<p>ELECTROLYTE IS CORROSIVE AND CONTACT MAY CAUSE SKIN IRRITATION AND CHEMICAL BURNS. IF YOU COME IN CONTACT WITH BATTERY ELECTROLYTE, TAKE THE FOLLOWING MEASURES:</p> <ol style="list-style-type: none"> <li>1. INHALATION: IMMEDIATELY EVACUATE THE CONTAMINATED AREA AND SEEK MEDICAL ATTENTION.</li> <li>2. EYE CONTACT: IMMEDIATELY RINSE EYES WITH WATER FOR 15 MINUTES AND SEEK MEDICAL ATTENTION.</li> <li>3. CONTACT WITH SKIN: WASH THE CONTACTED AREA THOROUGHLY WITH SOAP AND WATER AND SEEK MEDICAL ATTENTION.</li> <li>4. INGESTION: INDUCE VOMITING AND SEEK MEDICAL ATTENTION.</li> </ol>

### 3.4.3 FIRST-AID MEASURES FOR FIRE

	DANGER
	<p>IF A FIRE OCCURS DURING THE CHARGING OF THE BATTERIES, ISOLATE THE CHARGER FROM ITS POWER SUPPLY BY TURNING OFF THE POWER SWITCH AT THE INVERTER/PCS OR PUSHING THE E-STOP BUTTON ON THE SYSTEM ENCLOSURE.</p> <p>PUSH THE MANUAL RELEASING BUTTON ON THE SYSTEM ENCLOSURE IF THE AUTOMATIC FIRE SUPPRESSION SYSTEM IS NOT ACTIVATED BY ITSELF.</p>





	<b>DANGER</b>
	USE AEROSOL TO EXTINGUISH THE FIRE.

	<b>DANGER</b>
	FIREFIGHTERS NEED TO AVOID CONTACT WITH HIGH-VOLTAGE COMPONENTS DURING EXTINGUISHING, OR IT MAY RESULT IN THE RISK OF ELECTRIC SHOCK.

	<b>DANGER</b>
	WHEN THE BATTERY TEMPERATURE IS TOO HIGH, IT MAY CAUSE BATTERY DEFORMATION, DAMAGE, ELECTROLYTE OVERFLOW, AND TOXIC GAS LEAKAGE. WEAR PROTECTIVE RESPIRATORY EQUIPMENT AND KEEP AWAY FROM THE BATTERY TO AVOID SKIN IRRITATION AND CHEMICAL BURNS.

#### 3.4.4 FIRST-AID MEASURES FOR BATTERY DROP

	<b>DANGER</b>
	WHEN INSTALLING THE BATTERY, IF THE BATTERY DROPS OR SUFFERS A STRONG IMPACT, IT MAY CAUSE INTERNAL DAMAGE TO THE DEVICE. DO NOT CONTINUE TO USE THE BATTERY, OTHERWISE THERE MAY BE SAFETY RISKS (CELL LEAKAGE, ELECTRIC SHOCK, ETC.).

	<b>DANGER</b>
	AFTER THE BATTERY DROPS, IF THERE IS OBVIOUS ODOR, DAMAGE, SMOKE, FIRE, ETC., EVACUATE PERSONNEL IMMEDIATELY, CALL THE POLICE IN TIME, AND CONTACT PROFESSIONALS WHO WILL USE FIRE-FIGHTING EQUIPMENT TO EXTINGUISH THE FIRE WHILE ENSURING SAFETY.

	<b>DANGER</b>
	AFTER THE BATTERY DROPS, IF THERE IS NO OBVIOUS ODOR, DAMAGE, SMOKE OR FIRE CONTACT PROFESSIONALS TO TRANSFER THE BATTERY TO AN OPEN AND SAFE PLACE OR CONTACT A RECYCLING COMPANY FOR SCRAPPING.

### 3.5 BATTERY RECYCLING TREATMENT



#### CAUTION

DISPOSE OF USED BATTERY ACCORDING TO LOCAL LAWS AND REGULATIONS. DO NOT DISPOSE OF BATTERY AS HOUSEHOLD GARBAGE. IMPROPER DISPOSAL OF BATTERY MAY LEAD TO ENVIRONMENTAL POLLUTION.



#### CAUTION

IF THE BATTERY CELL LEAKS OR IS DAMAGED, CONTACT TECHNICAL SUPPORT OR A BATTERY RECYCLING COMPANY FOR DISPOSAL.



#### CAUTION

WHEN BATTERIES ARE OUT OF SERVICE LIFE, CONTACT A BATTERY RECYCLING COMPANY FOR SCRAPPING.



#### CAUTION

AVOID EXPOSING USED BATTERIES TO HIGH TEMPERATURES OR DIRECT SUNLIGHT.



#### CAUTION

AVOID EXPOSING USED BATTERY TO HIGH HUMIDITY OR CORROSIVE ENVIRONMENTS.

### 3.6 STORAGE REQUIREMENTS



#### IMPORTANT

DURING THE STORAGE PERIOD, RECORDS SHALL BE MADE ACCORDING TO THE STORAGE REQUIREMENTS OF THE PRODUCT IN THIS MANUAL, SUCH AS TEMPERATURE AND HUMIDITY, STORAGE ENVIRONMENT, ETC.

	<b>IMPORTANT</b>
	LONG-TERM STORAGE OF BATTERIES IS NOT RECOMMENDED. LONG-TERM STORAGE OF LITHIUM BATTERY WILL CAUSE CAPACITY LOSS. AFTER STORAGE AT THE RECOMMENDED STORAGE TEMPERATURE FOR 12 MONTHS, THE IRREVERSIBLE CAPACITY LOSS OF LITHIUM BATTERIES GENERALLY 3% TO 10%.

	<b>IMPORTANT</b>
	THE STORAGE ENVIRONMENT MUST MEET THE REQUIREMENTS OF LOCAL LAWS AND STANDARDS.

	<b>IMPORTANT</b>
	AFTER THE EXPIRATION DATE, THE STORAGE SYSTEM MUST BE INSPECTED AND TESTED BY PROFESSIONAL PERSONNEL BEFORE IT CAN BE PUT INTO USE.

	<b>IMPORTANT</b>
	WHEN STORING BATTERIES, PLACE THEM CORRECTLY ACCORDING TO THE LABEL ON THE PACKING CASE. DO NOT PUT THEM UPSIDE DOWN OR ON THE SIDE.

	<b>IMPORTANT</b>
	WHEN STACKING BATTERY PACKING CASES, COMPLY WITH THE PACKING REQUIREMENTS ON THE OUTER PACKAGING.

	<b>IMPORTANT</b>
	HANDLE THE BATTERIES WITH CARE. DO NOT DAMAGE THE BATTERY.

**Storage environment requirements:**

- Ambient temperature: -30 °C to 60 °C Recommended storage temperature:

20 °C to 30 °C

- Relative humidity: 5%RH to 80%RH.
- Store in a dry, clean and well-ventilated place, and prevent dust and water vapor from eroding. Do not suffer from rain or ground water erosion.
- Avoid contact with corrosive organic solvents, gases and other substances.
- Avoid direct sunlight.

### 3.7 HANDLING GUIDELINES

	<b>CAUTION</b>
	<p>THIS PRODUCT HAS PASSED THE CERTIFICATION OF UN38.3 (UN38.3: SECTION 38.3 OF THE SIXTH REVISED EDITION OF THE RECOMMENDATIONS ON THE TRANSPORT OF DANGEROUS GOODS: MANUAL OF TESTS AND CRITERIA) AND SN/T 0370.2-2009 "RULES FOR INSPECTION OF PACKAGING FOR EXPORT DANGEROUS GOODS-PART 2: PERFORMANCE TEST" AND BELONGS TO CLASS 9-MISCELLANEOUS DANGEROUS GOODS.</p>

#### HANDLING REQUIREMENTS:

- The energy storage system must be handled according to local laws, regulations, and industry standards. Rough handling may cause short circuit or damage to batteries in the container, which may result in battery leakage, rupture, explosion, or fire.

	<b>IMPORTANT</b>
	<p>DO NOT EXPOSE BATTERY MODULES TO TEMPERATURES ABOVE 50°C. THE OPTIMAL TEMPERATURE RANGE IS 23±5 ° C. EXPOSURE TO AN ENVIRONMENT BEYOND THIS RANGE CAN ACCELERATE BATTERY CAPACITY DEGRADATION.</p>

	<b>WARNING</b>
	<p>BE AWARE OF THE HEAVYWEIGHT OF BATTERY MODULES AND THE RISK OF A DROP.</p> <p>THE BATTERY MODULE NEEDS TO BE REPLACED IF SUFFERED A DROP. POTENTIAL INTERNAL DAMAGE MAY CAUSE AN SERIOUS FIRE INCIDENT EVEN THERE IS NO SERIOUS VISUAL EXTERNAL DAMAGE ON THE BATTERY MODULE.</p>

- Battery modules must be handled carefully and any exposure to shock or excessive

mechanical load could cause significant damage. In the event of a module being dropped during handling, storage, or installation, the battery module shall be returned to the ZOE service center for inspection.

	<b>WARNING</b>
	<b>DO NOT USE THE BATTERY MODULE IF ANY PART OF ITS HOUSING OR CONNECTORS EXHIBITS PHYSICAL DAMAGE.</b>

- Do not place battery modules on flammable construction materials, in areas where highly inflammable materials are stored, in potentially explosive environments, or high humid environments.
- Do not stack any objects on the battery module.
- Any mishandling of the battery module including dropping, deforming, impacting, cutting, or penetrating is likely to damage the unit and might cause a fire.
- Always ensure the battery is maintained with its top surface facing upwards. Do not place the module upside-down.

#### **SHIPMENT CONDITIONS:**

- Before shipment, check that the battery should be intact and not appear obvious odor, smoke, fire and other phenomena, otherwise the shipment is prohibited.

	<b>IMPORTANT</b>
	<b>PRODUCTS WHICH MEET THE REQUIREMENTS OF VEHICLE, SHIP AND OTHER TRANSPORTATION CAN BE DELIVERED DIRECTLY TO THE SITE, TRANSPORTATION PACKING BOXES MUST BE FIRM. HANDLE WITH CARE AND TAKE MOISTURE-PROOF MEASURES. SUBJECT TO EXTERNAL ENVIRONMENT (SUCH AS TEMPERATURE, TRANSPORTATION, STORAGE, ETC.), THE PRODUCT SPECIFICATIONS ARE SUBJECT TO THE MANUFACTURE DATE.</b>

#### **TRANSPORTATION PROCESS REQUIREMENTS:**

- Maritime transport in accordance with IMDG CODE.
- Land transport in accordance with ADR or JT T617.
- Meet the regulatory requirements of the transport regulatory authorities in the countries of origin, route and destination.

- Comply with international regulations for the transport of dangerous goods and the regulatory requirements of the corresponding national transport regulatory authorities.

**THINGS SHOULD BE PROHIBITED DURING HANDLING OR TRANSPORTATION:**

- Direct rain, snow or falling into water.
- Fall or mechanical impact.
- Invert or tilt.

	<b>IMPORTANT</b>
<p>IF ANY OF THE PRECEDING EXCEPTIONS OCCURS, HANDLE THEM ACCORDING TO FIRST-AID MEASURES.</p>	

### 3.8 PERSONAL PROTECTIVE EQUIPMENT

Please be aware that a battery can pose a risk of electrical shock including a high short-circuit current. Follow all safety precautions while operating the batteries. During the installation or maintenance of the battery system, a worker shall wear proper PPE such as eye protection, high visibility clothing, protective gloves, and protective footwear. Insulation gloves with over 1500VDC ratings are needed when connecting the busbars and jumpers between modules and racks.



<b>EYE PROTECTION</b>
<b>HIGH VISIBILITY CLOTHING</b>
<b>PROTECTIVE GLOVES</b>

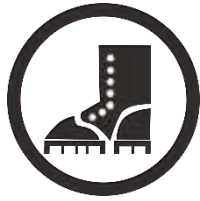

## PROTECTIVE FOOTWEAR

Figure 3-1: Safe gear for installation

- Wear appropriate personal protective equipment when operating the device. If a fault is found that may cause personal injury or device damage, terminate the operation immediately, report the fault to the person in charge, and take effective protective measures.
- Before using the tools, master the proper use of the tools to avoid injury and damage to the device.
- Do not touch the device when it is operating because the case is at a high temperature, which may cause burns.
- To ensure personal safety and normal use, ensure reliable grounding before use.
- Avoid contact with a faulty battery when the temperature may exceed the burn threshold for touchable surfaces.
- Do not open or damage the battery. The electrolyte released is harmful to skin and eyes. Avoid contact with it.
- Do not place irrelevant items on the top of the device or insert them anywhere of the device.
- Do not place combustible materials around the device.
- Do not place the battery in the fire to avoid explosions which may bring danger in personal safety.
- Do not place the battery module in water or other liquids.
- Do not short-circuit battery terminals. Short-circuited batteries may cause combustion.
- The battery may cause shock and a large short-circuit current hazard. When using batteries, pay attention to the following precautions:
  - ) Use tools with insulated handles.
  - b) Put on rubber gloves and boots.

- c) Do not place tools or metal parts on the top of the battery.
  - d) Disconnect the charging power supply before connecting or disconnecting the battery terminals.
  - e) Check whether the battery is accidentally grounded. If so, remove the power supply from the ground.
- Do not use water or detergent to clean electrical components inside or outside the container.
  - Do not stand, lean or sit on the device.
  - Do not damage any module of the device.



## 4 SYSTEM OVERVIEW

### 4.1 SYSTEM DESIGN

#### 4.1.1 PRODUCT SERIES

Table 4-1: Product series

MODEL	APPLICABLE REGION	NOTE
P3440L2H-B	IEC	0.5C

#### 4.1.2 SYSTEM DESCRIPTION

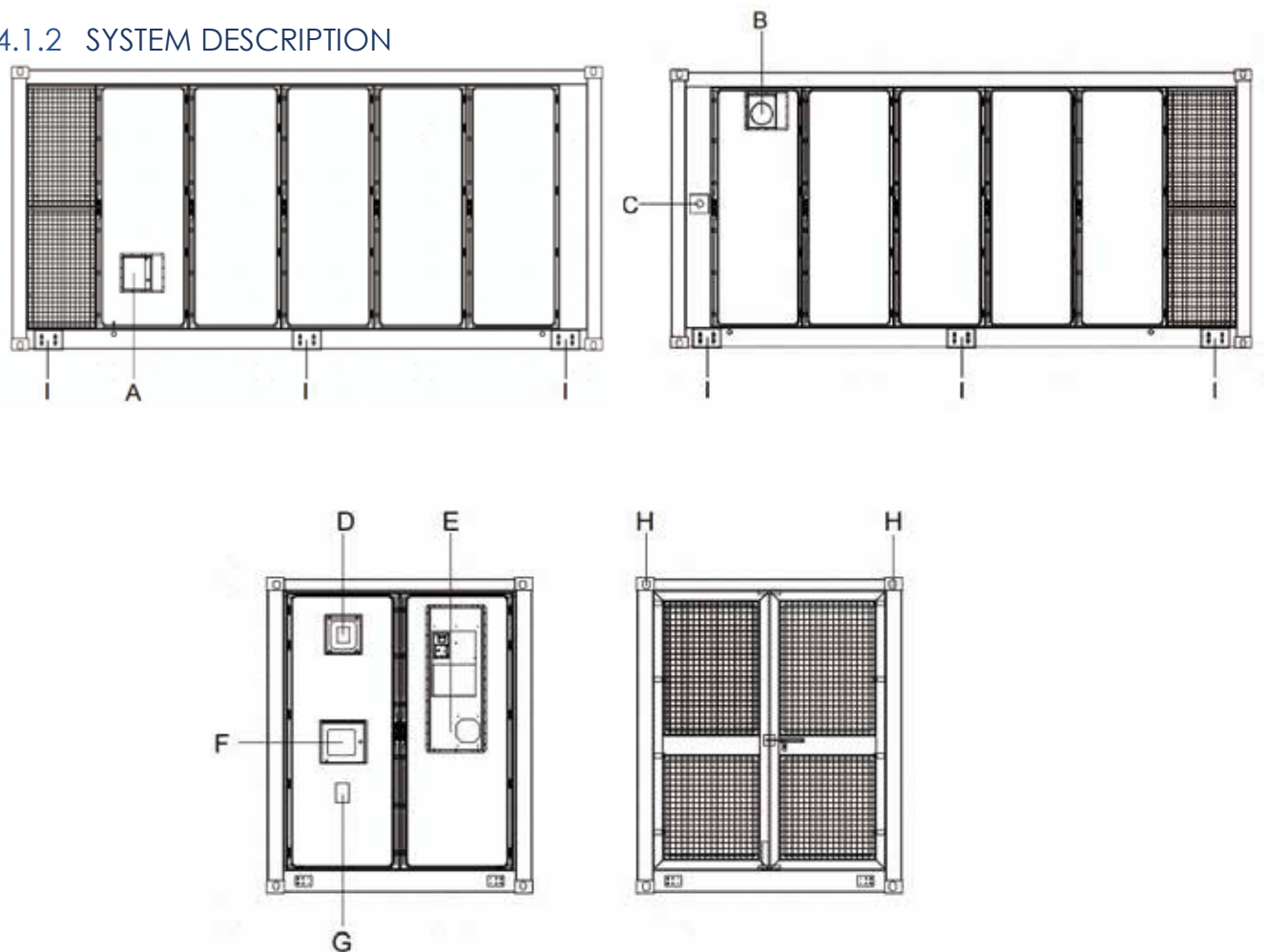

Figure 4-1: Appearance

Table 4-2: Introduction

NO.	ITEM	QTY	DESCRIPTION
-----	------	-----	-------------

A	Electric shutter	1	Inlet of fresh air outside the container
B	Deflagration venting fan	1	Outlet of air inside the container
C	Water fire suppression pipe coupling	1	Access customer station level water fire suppression pipe network
D	Audio-visual alarm device	1	Audio-visual alarm is issued when the fire is triggered in the container
E	Air-cooled HVAC	1	Distribution bin heat dissipation, dehumidification
F	System emergency stop button	1	Used for system emergency stop
G	Nameplate	1	Display container parameters, date of manufacture and other information
H	Top corner fitting	4	Used for container lifting
I	L- bracket	6	Used for container anchoring

### 4.1.3 SPECIFICATION

Table 4-3: Specification

BATTERY PARAMETERS	
Cell type	3.2V/280Ah
Configuration	384S*10P
Nominal capacity	3440.64 kWh
Voltage range	1075.2~1382.4V
SYSTEM PARAMETERS	
Dimensions(W×D×H)	6058mm×2896mm×2438mm
Weight	33.5±0.5T
Operating temperature	-30~50 °C (de-rating > 45°C)
Charge-discharge rate	0.5C(P3440L2H-B)
Operating humidity	0~95% (non-condensing)
Anti-corrosion grade	C4-M
Protection grade	IP55
Thermal method	Intelligent liquid cooling
Fire suppression design	Water + Combustible gas detection + Ventilation fan + Aerosol (optional)
Allowable working altitude	≤3000m
Noise	≤80dB@1m
Wind load	49.9m/s
Snow load	40psf
Seismic zone	Zone 4

## 5 MAIN SYSTEM EQUIPMENT

### 5.1 BATTERY SYSTEM

#### 5.1.1 BATTERY CELL

ZOE Battery storage systems rely on advanced LFP chemistry to provide a combination of high performance, low cost, and industry-leading safety. Configurable to serve the application at hand, 3.2V 280Ah prismatic cells became ZOE’s best pick for a battery storage solution. Cell specifications are as follows.

Table 5-1: Specification of the Battery cell

ITEM	UNIT	SPECIFICATION	RENDERING
Battery Chemistry	-	LFP	
Shape	-	Prismatic	
Dimension(W×D×H)	mm	173.9×71.7×207.2	
Weight	kg	5.34±0.3	
Nominal Capacity	Ah	280	
Nominal Energy	Wh	896	
Nominal Voltage	Vdc	3.2	
Operating Voltage	Vdc	2.8~3.6	
Operating Temperature Range	°C	Charge: 0~60. Discharge: -20~60	

#### 5.1.2 BATTERY MODULE

ZOE deploys modular design which allows for customized configurations, ease of maintenance, and future expansion capability. Modules are formed by configuring 48 LFP cells in a series connection. Modules are connected with a battery management system (BMU) to form a rack-mountable module assembly. Multiple module assemblies are then combined into a rack. Each rack contains rack-level BMS.

Table 5-2: Specification of Module

ITEM	UNIT	SPECIFICATION	RENDERING
Configuration	-	1P 48S	
Key Component	-	48 cells, module BMU	
Dimension(W×H×D)	mm	1111.2×246.44×810	
Weight	kg	310	
Nominal Capacity	Ah	280	
Nominal Energy	kWh	43.008	
Nominal Voltage	Vdc	153.6	
Operating Voltage	Vdc	134.4~172.8	
Maximum Power	kW	21.5	
Storage Temperature	°C	-30~60	
Storage Humidity	%	≤85	

(For reference only)

### 5.1.3 BATTERY RACK

All wire connections are placed on the front side of the rack to allow for easy installation and maintenance.

Table 5-3: Specification of Battery Rack

ITEM	UNIT	SPECIFICATION	RENDERING
Configuration	-	384S*10P	 <p>(For reference only)</p>
Number of Modules	EA	40	
Key Component	-	40 Modules, 5 BSPU (DC Switchgear)	
Switchgear Position	-	Top	
Dimension(W×H×D)	mm	6,058×2,896×2,438	
Weight	T	33.5±0.5	
Nominal Capacity	Ah	280	
Nominal Energy	kWh	3440.64	
Operating Voltage	V	1075.2~1382.4	
Operating Temperature Range	°C	-30~50 °C (de-rating > 45°C)	
Storage Temperature	°C	-30~60	
Operating Humidity	%	0~95% (non-condensing)	
Degree of Protection		IP55	

The battery safety and protection unit (BSPU) are physically located at the top of the RACKs. A RACK is consisting of 8 packs connected in series. The BSPU is consisting of an isolating switch, positive and negative independent fuses, a contactor, a detecting unit, sampling wires, BMS, a control unit, etc. The BSPU has the function of high voltage detection and precharge.

### 5.1.4 BATTERY MANAGEMENT SYSTEM

The BESS employs a sophisticated, multilevel battery management system (BMS) for system monitoring and control. Each multilevel battery management system includes:

- Module Battery management unit (BMU)
- Rack Battery Management Controlling System (RBMS)
- System-level BMS (SBMS)



Figure 5-1: SBMS interface to Ethernet Switch

The Module BMS (BMU) is designed to detect voltage and temperature and execute cell balance functions for cells. The rack BMS (RBMS) can manage all module BMS units and detect total voltage, current, and executes protection functions by switching the DC-contactor. Finally, a system-level BMS (SBMS) manages rack BMS units and communicates with PCS or EMS. The table below outlines the BMS units of the system.

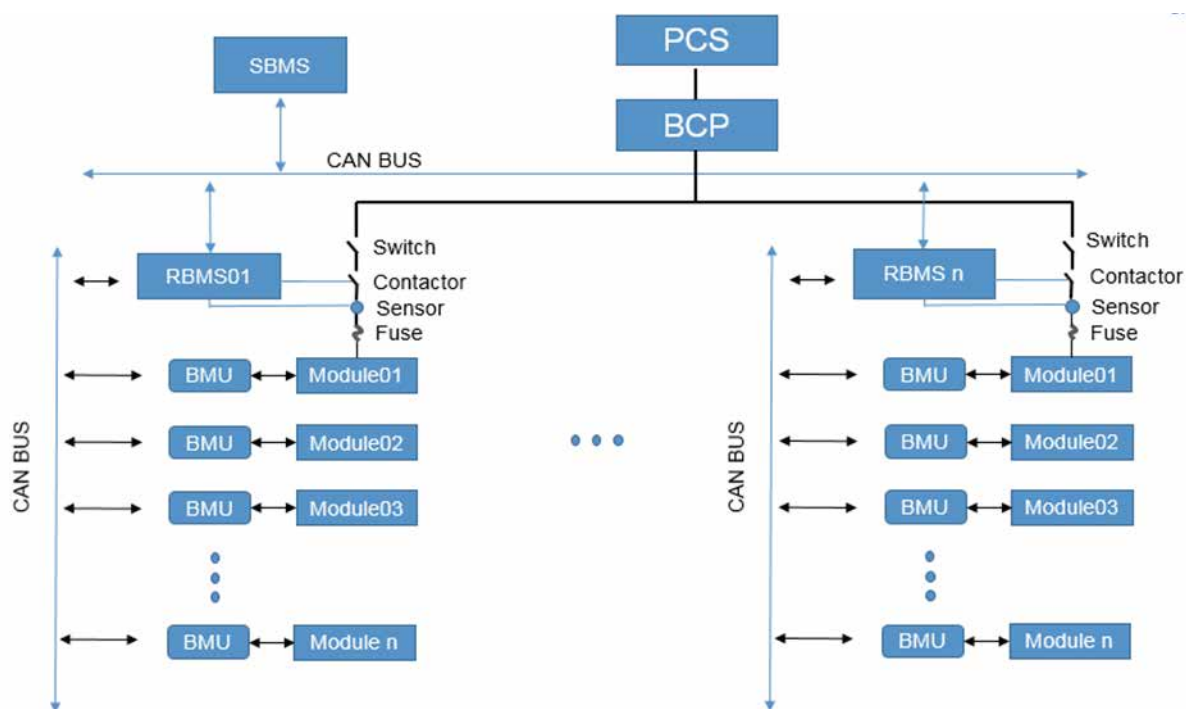

Figure 5-2: Architecture of the BMS

The functionalities of each level of BMS are shown in the following table.

Table 5-4: BMS Functionality

FUNCTIONALITY		BMU	RBMS	SBMS
Measurement	Cell Voltage	√		
	Cell Temperature	√		
	Rack Voltage		√	

	Rack Current		√	
Calculation	SOC		√	√
	SOH		√	√
	Power Prediction		√	
Control	Contactor Control		√	
	Cell Balancing	√	√	
	CAN2.0	√	√	
Communication	RS485			√
	Ethernet			√

## 5.2 GOLDEN SHIELD CONTROLLER

To offer one universal communication interface for battery systems with SCADA or EMS and release EMS from basic system protection, ZOE deploys a system controller as part of the BESS integration.



Figure 5-3: Rendering of Golden Shield

### 5.2.1 FEATURES AND FUNCTIONS

Control integration of the battery system (include battery BMS, cooling units, BCP etc.). Offer a universal interface for communication between battery systems and SCADA or EMS.

As a communication adapter, converts various communication protocols (RS-485, CAN, dry contact, etc.) of BOS devices such as BMS, PCS, HVAC, and FSS into a communication protocol of the EMS for easy integration.

Take basic system protection measures to prevent the battery and PCS from being damaged during operation.

Data logging (short period) for troubleshooting.

Remote firmware updating(pending).

## 5.2.2 COMMUNICATION TOPOLOGY

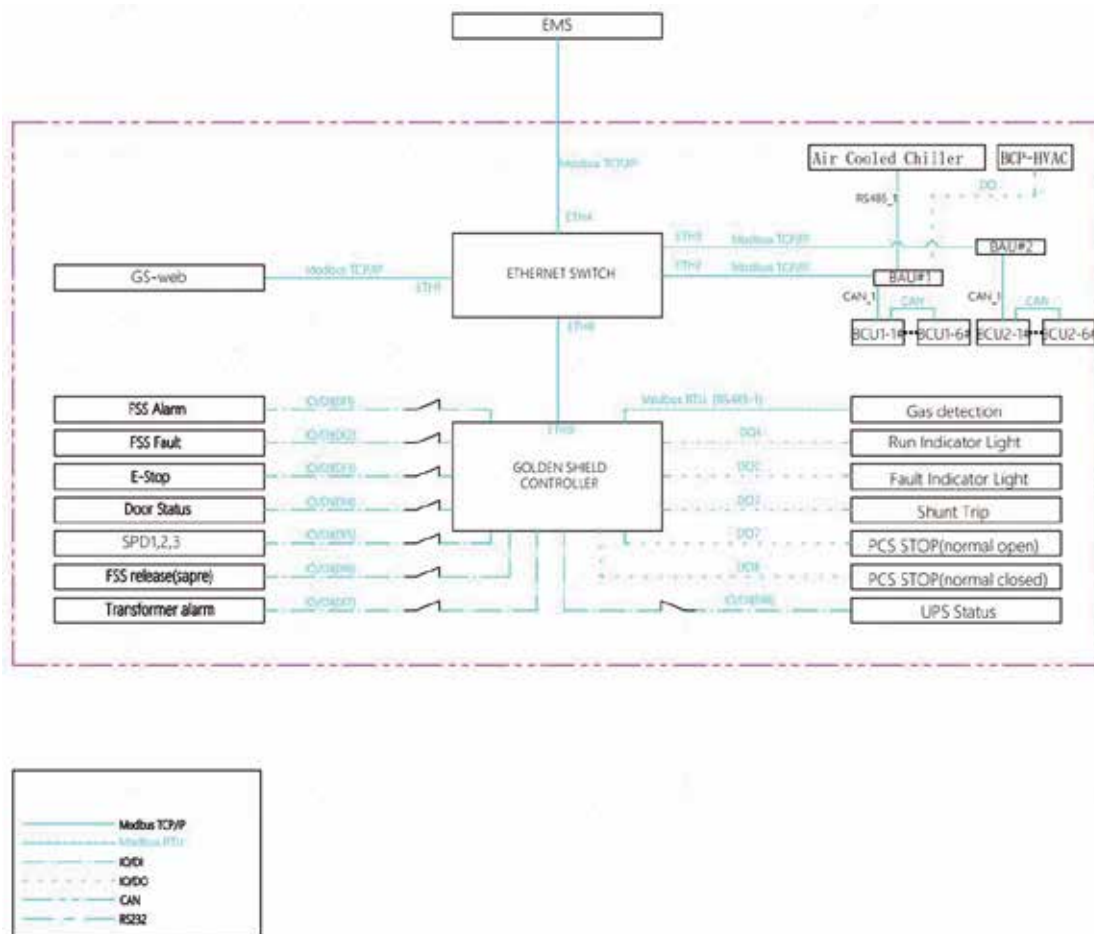

Figure 5-4: Communication topology with Golden Shield

## 5.3 THERMAL MANAGEMENT SYSTEM

### 5.3.1 COOLING CONCEPT

The liquid cooling system will be designed and installed inside the battery container.

#### 1. Advantages of Liquid Cooling

- Higher cooling capability: compare to air cooling, liquid cooling is capable of

taking more heat away from batteries under the same condition. And liquid cooling is the best choice when thermal density is beyond the capability of air cooling.

- Better temperature uniformity: Cooling liquid has a specific heat capacity which leads to a smaller temperature rise during the cooling process. Therefore, battery cells will have a smaller temperature difference with liquid cooling.
- Lower Noise Emission: Without fans on battery modules for air cooling means no noise emission from battery modules.

## 2. Working principle of Liquid Cooling

- Battery Cooling: Cooling liquid powered by the pump will circulate inside battery modules and take the heat from batteries. When the liquid gets out of the battery modules, it became hot liquid with the heat from batteries. The hot liquid will circle back to a heat exchanging tank.
- Heat Exchanging: Inside the heat exchange tank, the refrigerant will vaporize from liquid state to gaseous state. During this state/phase change process, the refrigerant will absorb a huge amount of heat from the battery cooling liquid and cool down the cooling liquid.
- AC Cooling: The rest of the system is a standard Air Conditioner which releases the heat to the environment through the phase change of the refrigerant.

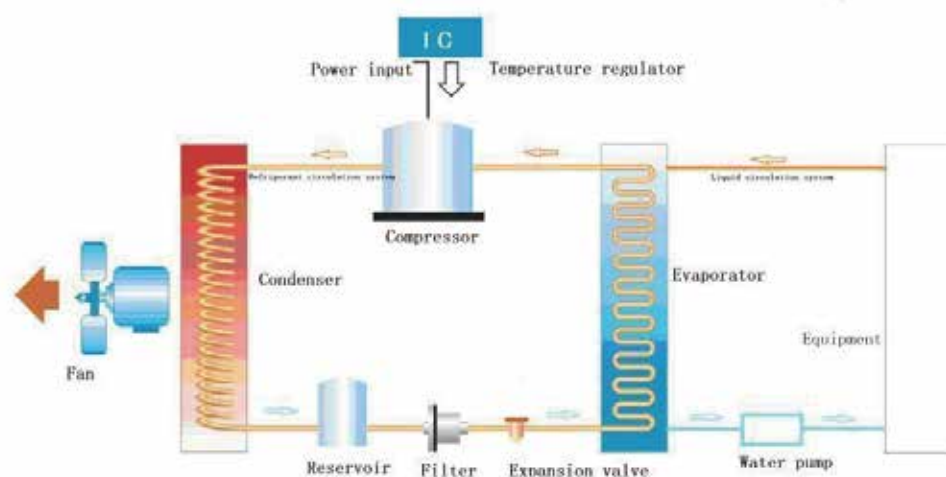



Figure 5-5: Working principle of Liquid Cooling

### 5.3.2 HVAC INTRODUCTION

The HVAC consists of 1 set of 3kW air-cooled HVAC and 2 sets of 40kW liquid-cooled chillers.



Table 5-5: Specification of HVAC

ITEM	UNIT	SPECIFICATION	RENDERING
Make	-	ENVICOOL	
Model	-	MC30HDNC1U or equivalent	
Dimension(W×H×D)	mm	500×1,300×250	
Weight	kg	66	
Mounting Method	-	Wall-mounted	
Working Temperature Range	°C	-40 ~ +55	
Noise Level	dB(A)	65	
IP Protection	-	IP 55	
Refrigerant	-	R410a	
RoHS Compliant	V	Yes	
Cooling Capacity@L27/L35 50Hz	W	3,000	
Heating Capacity @ Tu=10°C	W	1,000	
Power Consumption@L27/L35 50Hz	W	1,100	
Internal Airflow	m³/h	700	
Power Supply Range	V, Hz	220±10%, 50/60	
Max. Current	A	8.5	

ITEM	UNIT	SPECIFICATION	RENDERING
Make	-	ENVICOOL or equivalent	
Model	-	EMW400HDNC1C or equivalent	
Dimension(W×H×D)	mm	630×2,400×980	
Weight	kg	480	
Mounting Method	-	Floor-standing	
Working Temperature Range	°C	-30 ~ +55	
Noise Level	dB(A)	75	
IP Protection	-	IP X5	
Refrigerant	-	R410a	
Secondary Refrigerant		50% Glycol Solution	
RoHS2.0 Compliant	V	Yes	
Cooling Capacity@L45/W18	kW	40	
Heating Capacity	kW	12	
Cooling Power Consumption@ L45/W18	kW	17.37	
Heating Power Consumption@ Tu=10°C	kW	14.73	
Self-circulating Model (Single Pump Operation) Power	kW	2.73	
Maximum Power Consumption	kW	17.69	
Water Flow Rate	L/min	320@200kPa	
Power Supply Range	V, Hz	380-480±15%V, 3~, 50/60±3Hz	

### 5.3.3 HVAC INTERFACE

#### 5.3.3.1 AIR-COOLED HVAC

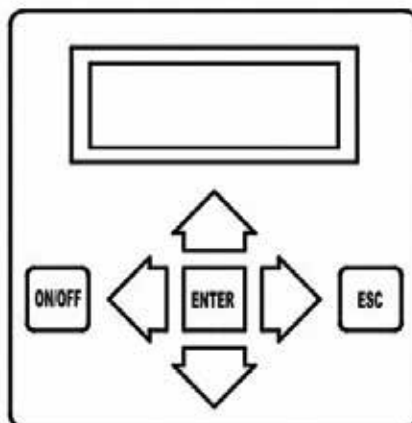

- ON/OFF: ON/OFF button, which can be used to turn on/off the unit:
- ↑: UP button, which is used to select the previous record/menu or increase the setting value (password only);
- ↓: Down button, which is used to select the next record/menu or decrease the setting value (password only);
- ←: Left button, which is used to increase the setting value or select the previous data while conducting password operation.
- →: Right button, which is used to decrease the setting value or select the next data while conducting password operation.
- ENTER: Return button, which is used to confirm the input.
- ESC: Quit button, which is used to return to the previous page menu.

if there is no keyboard operation for consecutively 60s under any interface after startup.it will automatically return to the normal display interface.

When any button is pressed after the system is powered up, the backlight will turn on. If there is no keyboard operation for consecutively 60s, the backlight will be off.

The operation password of the unit is "0001". On the normal interface, press Enter to enter the password input interface. Press the left button and the right button to select the desired digit, press the up button and the down button to modify the digit, and press Enter to confirm the input. If the password is incorrect, an error message is displayed, and the unit Settings cannot be modified. If the password is correct, enter the main menu, you can edit

the unit Settings.

Note: The actual parameters in the menu have been set before the factory as required by the customer.

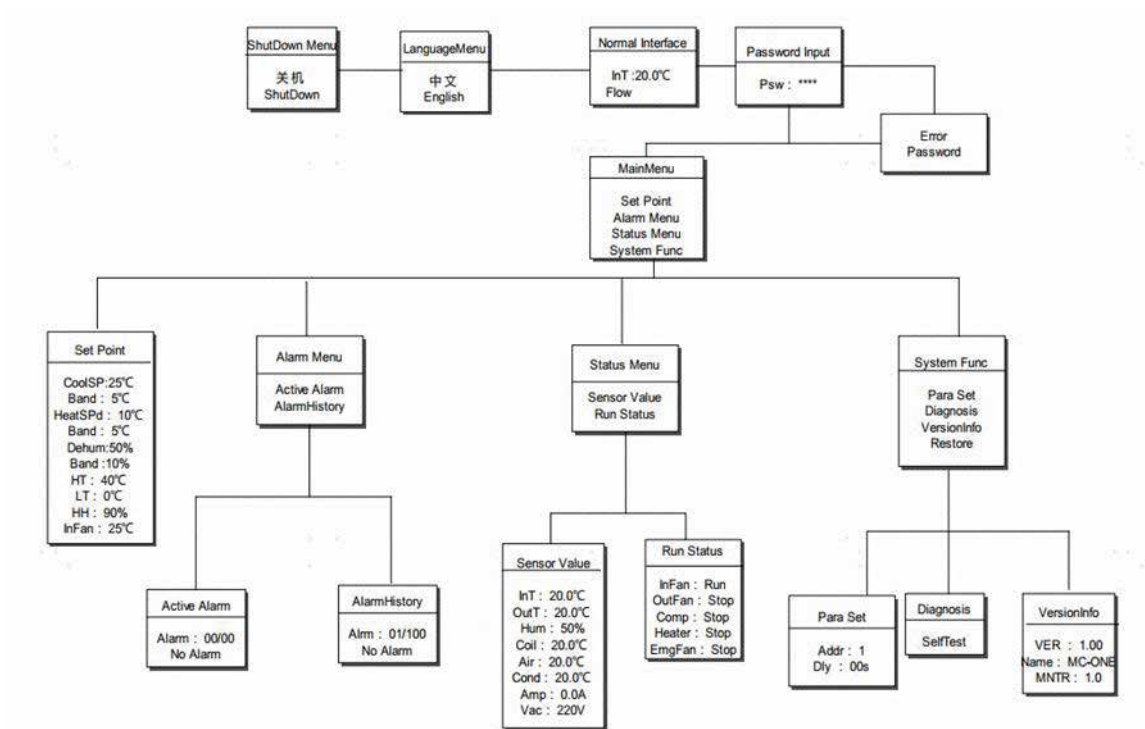

Figure 5-6: Unit menu structure diagram

### 5.3.3.2 LIQUID COOLING UNIT

#### ➤ Introduction

The controller part of EMW air-cooled liquid cooling unit is equipped with a touch screen display to provide users with a human-computer interaction interface. Users can query, set up and monitor conveniently through the touch screen to ensure the normal operation of the chiller.

#### ➤ Control System Interface

Turn on the power switch to power on the unit, and enter the control system homepage after the system is initialized, as shown in the figure below.



Figure 5-7: Control system homepage interface

On the main interface, you can open/close the coolant supplement function and the air discharge function of the circulation pump. After the system is powered on, press any key and the backlit light will light up. If there is no keyboard operation after a period of time, the backlit light will dim. The meanings of icons in the control interface of the chillers are shown in the figure below.

Icon	Description
	Switch button icon, click it to change the current working state of chiller.
	Language icon, click it to switch the language of the current interface to <b>Chinese</b> or <b>English</b> .
	Working status icon, which displays the current working status of chiller in the form of indicator lights. <ul style="list-style-type: none"> <li>Green indicates running status.</li> <li>Red indicates the shutdown state.</li> </ul>
	Alarm icon, which indicates that the current chiller has generated alarms.
	Circulating pump icon, which indicates that the circulating pump of the chiller is working.
	Cooling icon, which indicates that the chiller is in cooling state, and the compressor is working.
	Heating icon, which indicates that the chiller is in heating state, and the heater is working.
	System homepage icon, click it to enter the operation homepage interface of the control system, you can view the current time, operation mode, outlet temperature, outlet pressure and interface language of the chiller.
	System status icon, click it to enter the <b>System Status</b> interface, you can view the environment status, running status and group control status.
	System alarm icon, click it to enter the <b>Alarm</b> interface, you can view current alarms and historical alarms.
	System operation record icon, click it to enter the <b>Record</b> interface, you can view the chiller's operation record, operation log and operation curve.
	System setting icon, click it to enter the <b>Parameter Setting</b> interface, you can set the temperature and humidity setting, system configuration, account setting and time setting.
	System maintenance icon, click it to enter the <b>Maintain</b> interface, you can manually start the coolant replenishment function, and set the replenishment related time parameters.

Figure 5-8: Control interface icons

### ➤ System Start-up and Shutdown

After clicking the switch button every time, the system switches the working state of the current unit. The dialog box that pops up when the unit is start up is shown in the figure

below.



Figure 5-9: System start-up

After start-up, the status of unit changes from to "Running". On any interface, If there is no keyboard operation for a period of time, the system will automatically return to the homepage interface. The dialog box popped up when shutting down is shown in the figure below.



Figure 5-10: System shutdown

After shutting down, the chiller will be updated from running status to shutdown status. The system supports power-off memory function. If the system is powered on after power off, the system will automatically enter the state before power off (for example, if the system was on before power off, the system will automatically start up and enter the normal display interface after power on).

➤ Status

Click "Status" on the main interface of the control system to view the current environmental status and operation status of the unit, as shown in the figures below.



Figure 5-11: Environment Status interface



Figure 5-12: Run Status interface

## 5.4 FIRE SUPPRESSION SYSTEM

### 5.4.1 FIRE CONTROL FLOW CHART

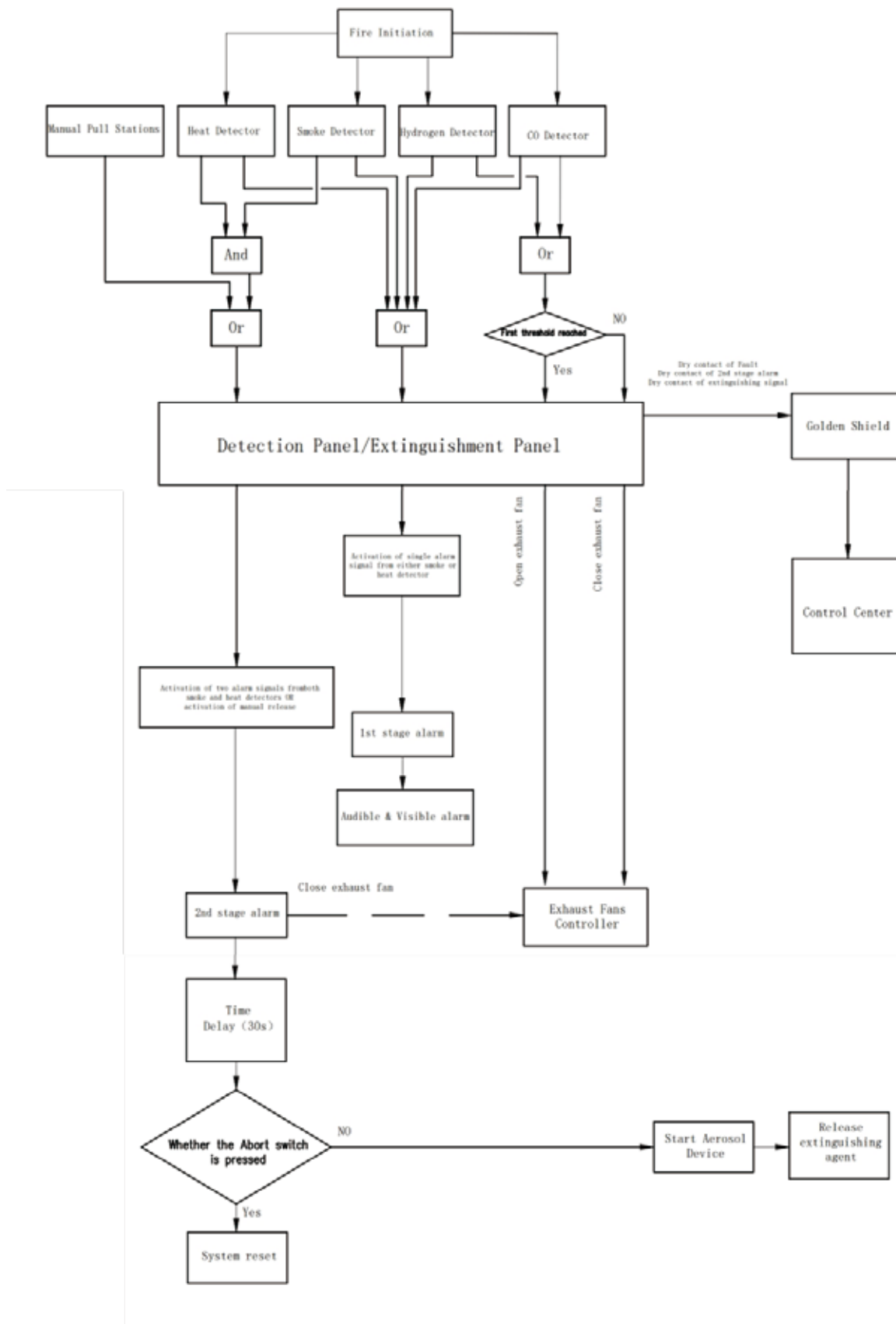

Figure 5-13: Fire control flow chart

Table 5-6: Device list

No.	Name	Qty	Note
1	Point type photoelectric smoke detector	2	Automatic sensitivity, meet NFPA72 requirements
2	Point type heat detector	2	Trigger threshold 135°±7.5°F
3	Audible & Visible alarm	1	
4	Combustible gas detector(CO)	2	Trigger threshold adjustable from 50 to 1000ppm
5	Combustible gas detector(H2)	2	Trigger threshold 1000ppm
6	Manual Pull Stations	1	
7	Extinguishing Abort switch	1	
8	Lead acid battery	2	Installed with gas fire control unit
9	Extinguishment Panel	1	
10	Fan control module	1	Built-in TPF13 explosion-proof fan
11	Explosion-proof exhaust fan	1	
12	Electric shutter	1	
13	Aerosol device	8	

#### 5.4.2 FIRE SUPPRESSION SYSTEM

When the temperature rises sufficiently, the extinguisher automatically and efficiently generates and releases an ultra-fine potassium-based aerosol with the assistance of a series of auxiliary components. The patented design, aerosol composition, and the ultra-fine particle size work together to greatly interrupt the reaction between oxygen and combustible materials, thus extinguishing the flame.

Compared to gas fire extinguishing systems, aerosol extinguishers offer higher performance while using the same weight of the agent. Aerosol extinguishers do not require pressurized vessels, pipes or other expensive components. They are virtually maintenance-free, have a service life of over ten years, and have a minimal size and weight. All of these advantages make aerosol fire extinguishers a highly cost-effective solution for fire prevention.





Figure 5-14: Aerosol automatic fire extinguisher (for reference)

### 5.4.3 FIRE DETECTION AND ALARM SYSTEM

For each 20-ft battery container, two smoker detectors, two temperature detectors, and two flammable gas detectors will be designed and installed.

When one of the smoker or temperature or flammable gas detector alarms, the alarm bell will alarm. When both smoker and temperature detectors alarm, the sound & light alarm will alarm and the fire suppression system will discharge simultaneously.



Figure 5-15: Smoker and Temperature Detector (for reference only)



Figure 5-16: Flammable Gas Detector (for reference only)

#### 5.4.4 WATER SPRINKLER SYSTEM

ZOE provides a water sprinkler piping system, inside the battery container there are 8 sprinkler nozzles, which evenly distribute to the 2 side of the battery container.

The Client should provide the external water source and external piping system and connect to the reserved water spray inlet port of the battery container.



Figure 5-17: Water Sprinkler Nozzle (for reference only)

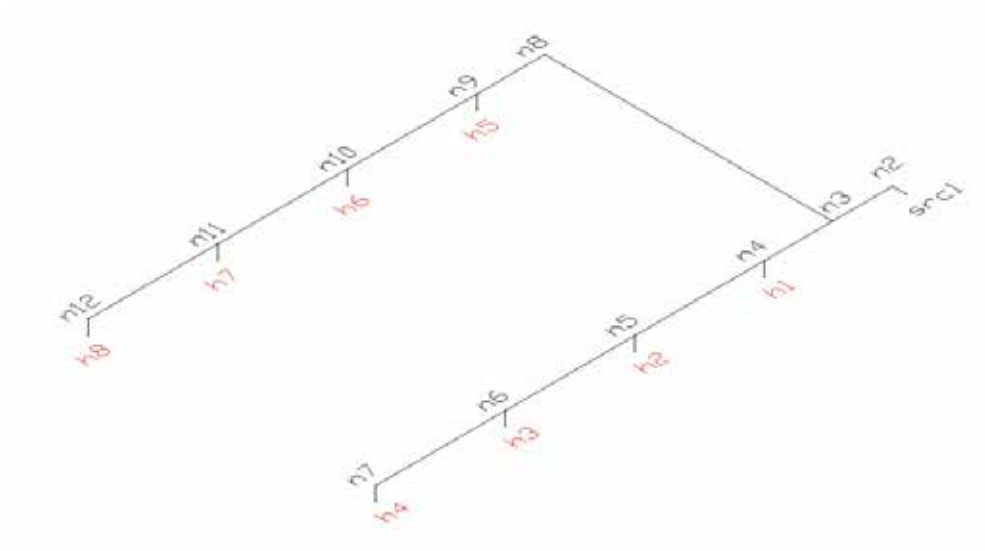

Figure 5-18: Water Sprinkler System (for reference only)





## 6 INSTALLATION

The battery system is a high-voltage energy storage device, which is regarded as dangerous goods. Non-professionals and improper operation and use may cause serious consequences such as electric shock, burning, and explosion. The battery system must be installed and maintained by professional technicians and used in strict accordance with the relevant safety provisions.

### 6.1 MAIN TOOLS AND COMPONENTS FOR INSTALLATION

Tools needed for the system installation are listed below.

Table 6-1: Tools for system installation

NO.	ITEM	PURPOSE	SAMPLE
1	Cutter	Unpacking	
2	Insulated Torque wrench	Use to install power connection	
3	Insulated driver	Use to install power connection	
4	Multi-meter	Voltage measurement	
5	Insulation gloves	Battery power connection	

**6**      Insulation shoes                      Safety protection



**7**      Wrench set                                  Busbar connection



**8**      Drill( $\Phi 16$ )                                  Hole the expansion bolts

**9**      Expansion bolt(SUS316 stainless steel M16X100)                      Connect the foundation to the device L-brackets

**10**      Electric hand drill, sleeve assembly and screwdriver assembly                      Installation of grounding cable, power cable, rubber tunnel, forklift hole sealing plate

**11**      Marking pen                                  Torque mark

**12**      Cable tie    Cable fixation

**13**      Goggles    Arc protection

## 6.2 PREPARATION FOR INSTALLATION

### 6.2.1 INSTALLATION ENVIRONMENT REQUIREMENTS

- The installation and use environment must comply with local laws and regulations and relevant international and regional standards for lithium electric products.
- For areas with frequent natural disasters such as floods, mudslides, earthquakes and typhoons, appropriate preventive measures shall be taken for installation.
- Keep the installation location away from fire and heat sources. Do not place combustible or explosive materials around the device.
- When the device is running, do not block the vent or thermal management system to prevent fire caused by high temperature.
- Do not place the device in an environment with combustible or explosive gas or smoke. Do not perform any operations in such an environment.

IMPORTANT	
	<p>THE OPERATION AND SERVICE LIFE OF THE ENERGY STORAGE DEPENDS ON THE OPERATING TEMPERATURE. INSTALL THE STORAGE DEVICES AT A TEMPERATURE EQUAL TO OR HIGHER THAN THE AMBIENT TEMPERATURE.</p> <p>THE OPERATING TEMPERATURE OF THE P3440L2H-B SERIES BATTERY CONTAINER RANGES FROM -30 °C TO 50 °C . IF THE CONTAINER IS STORED IN A COLD ENVIRONMENT (SUCH AS 0°C) BEFORE INSTALLATION, IT WILL TAKE SOME TIME TO HEAT UP BEFORE IT CAN BE RECHARGED.</p> <p>WHEN THE AMBIENT TEMPERATURE IS HIGHER THAN 45 ° C OR LOWER THAN 0 ° C, THE BATTERY CHARGING AND DISCHARGING POWER DECREASES.</p>

### 6.2.2 CHECK BEFORE INSTALLATION

#### 1) Outer packing check

Before opening the outer packaging of the product, please check the outer packing for obvious damage, such as breakage, cracks or other signs of possible internal damage, and check the product model. If there is any abnormal packaging or product type

discrepancy, please contact us as soon as possible.

2) Deliverable check

After unpacking the product, please check the deliverables for completeness and for any obvious external damage. If anything is missing or damaged, please contact us.

	IMPORTANT
REFER TO "SPARE PARTS" LIST FOR DETAILS OF THE SPARE PARTS DELIVERED WITH THE CASE.	

3) Installation foundation check

Before product installation, it is necessary to check the prefabricated foundation at the project site and ensure that the foundation is solid and reliable and meets the flatness requirements.

### 6.2.3 INSTALLATION SPACE

When installing devices, ensure that there are no combustible or explosive materials around, and reserve enough space to ensure heat dissipation and safety isolation. According to the highest ambient temperature of the project site, the installation and maintenance space of container liquid cooling unit is different as follows:

#### 6.2.3.1 HIGHEST AMBIENT TEMPERATURE $\geq 45^{\circ}\text{C}$

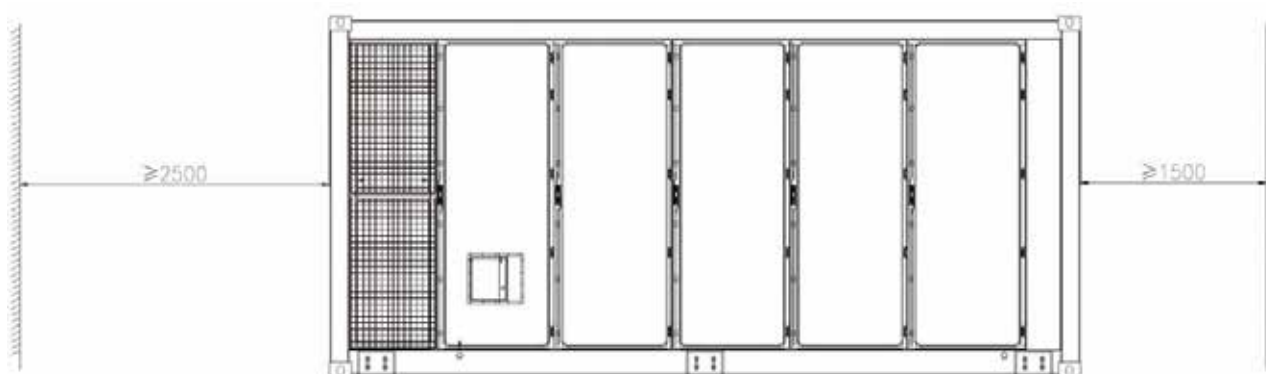

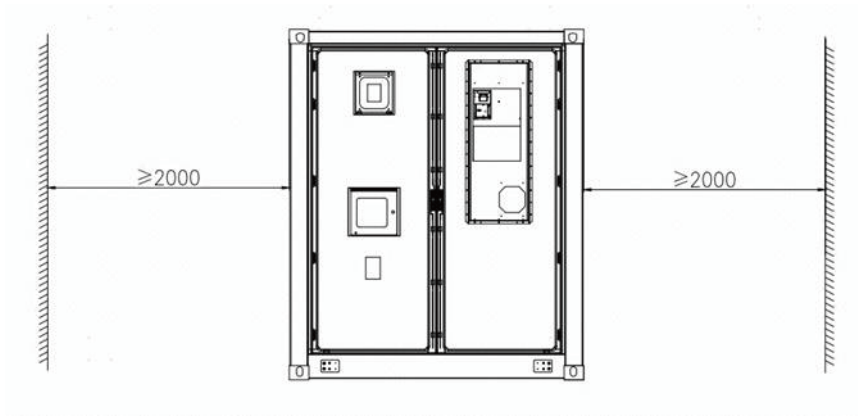

Figure 6-1: Installation space requirements for single container (unit: mm)

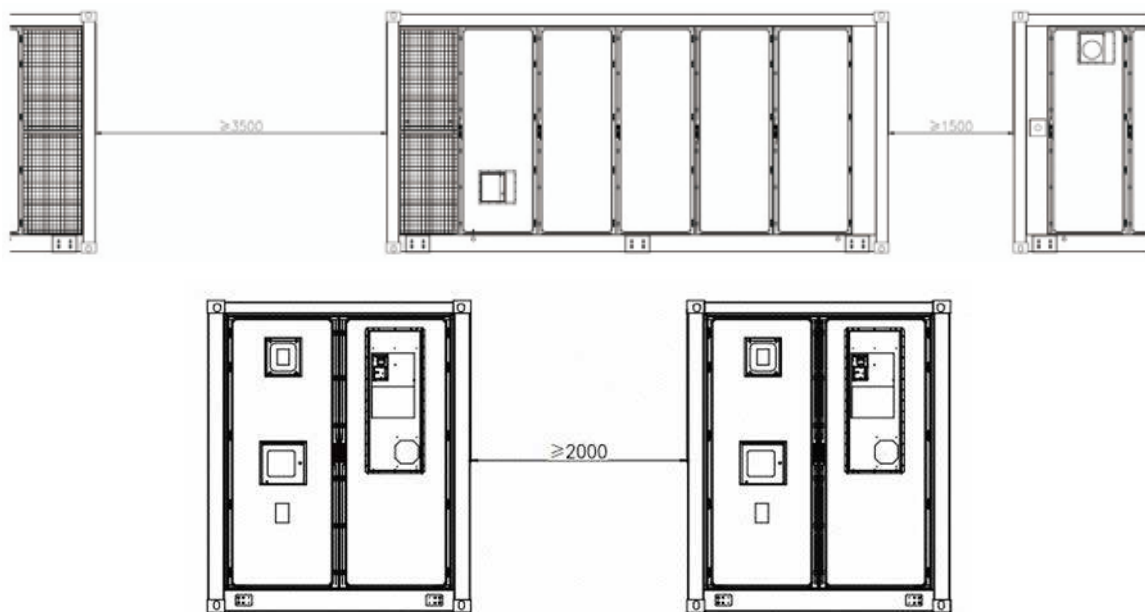
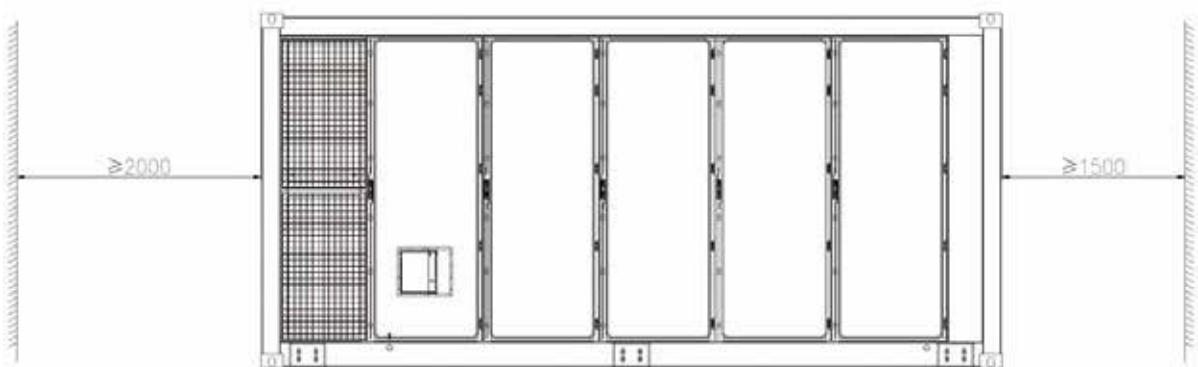

Figure 6-2: Installation space requirements for containers (unit: mm)

### 6.2.3.2 HIGHEST AMBIENT TEMPERATURE < 45°C





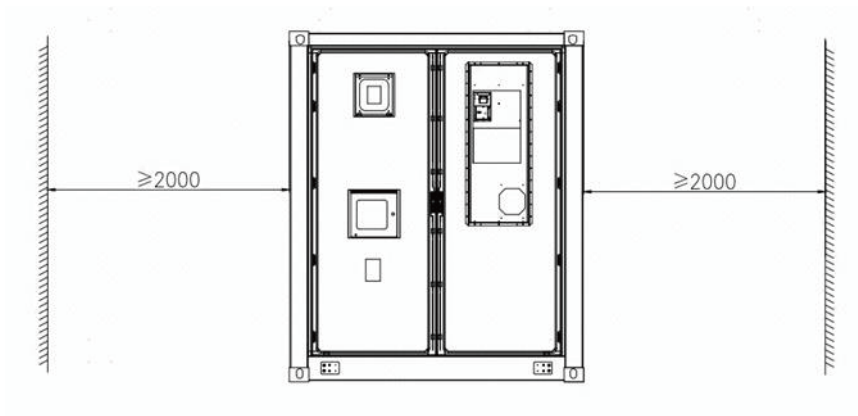

Figure 6-3: Installation space requirements for single container (unit: mm)

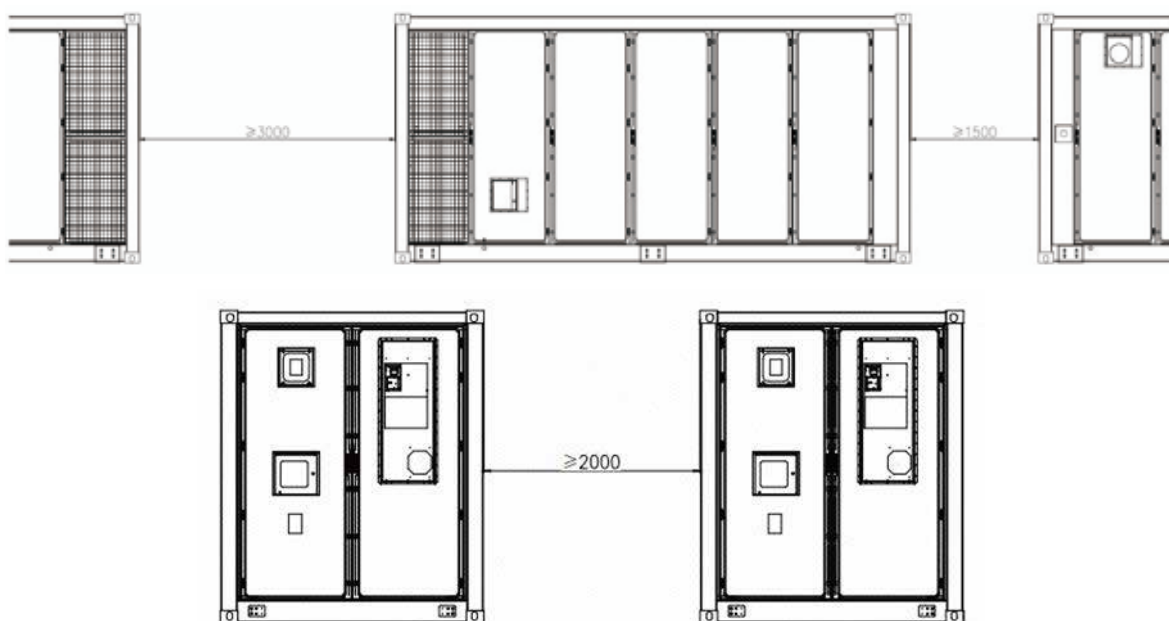

Figure 6-4: Installation space requirements for containers (unit: mm)

#### 6.2.4 FOUNDATION REFERENCE

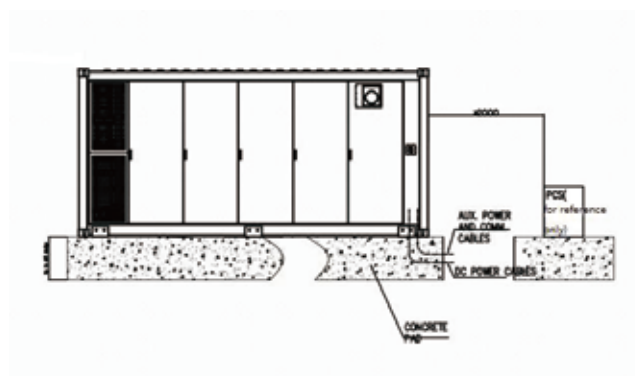

Figure 6-5: Foundation Reference Front View (unit: mm)

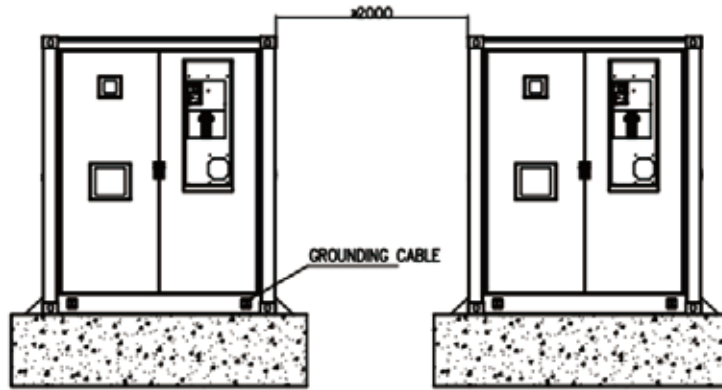

Figure 6-6: Foundation Reference Left View (unit: mm)

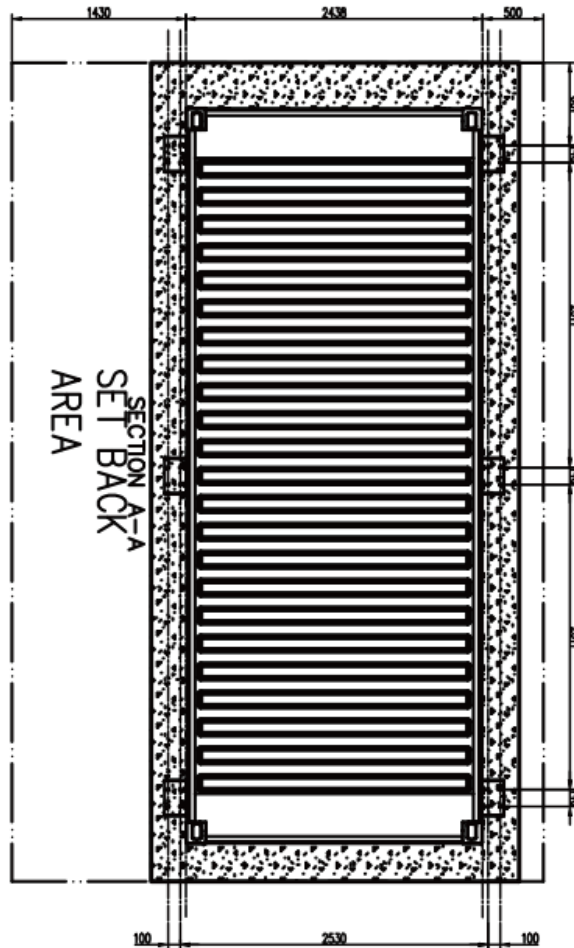
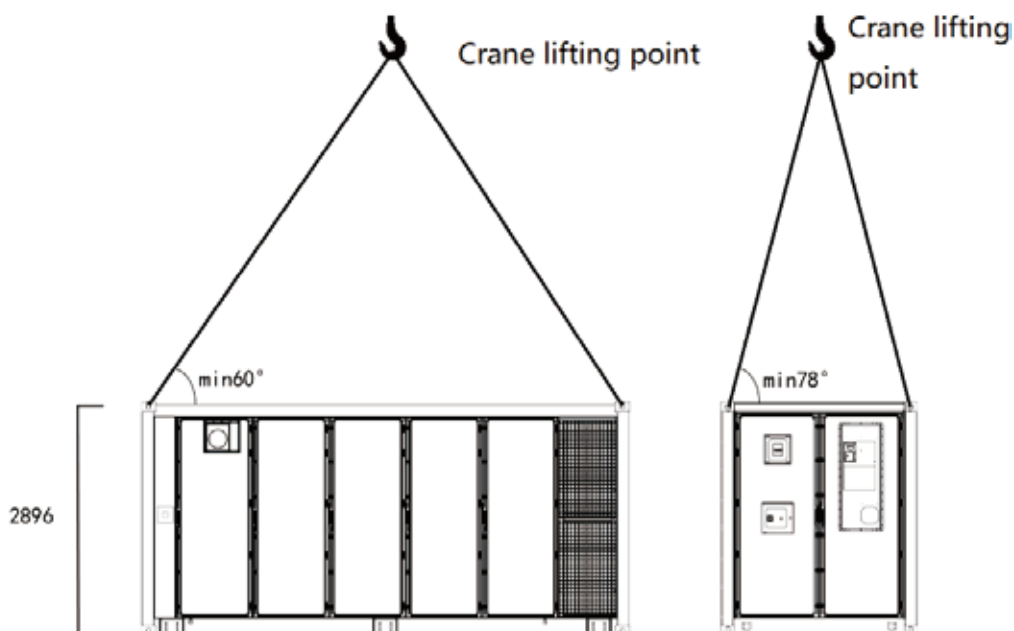

Figure 6-7: Foundation Reference Top View (unit: mm)

## 6.3 PRODUCT HANDLING

When crane lifting, note the following:

- Hoisting according to the site conditions, select the appropriate hoist. The load-bearing capacity of the selected crane is  $\geq 100t$ .
- The lifting equipment is equipped with 4 wire ropes, each length  $\geq 6.5m$ , bearing capacity  $\geq 15t$  and four clasp rings, each bearing capacity  $\geq 17t$ .
- Lifting Angle  $\geq 60^\circ$  . Before lifting, ensure that there are no obstacles around.
- During crane operation, no personnel shall stay or pass under the boom and equipment.
- In case of strong breeze or wind of higher force on Beaufort Wind Scale, heavy rain, heavy snow, heavy fog, the lifting operation should be suspended.
- The lifting or landing should be at a constant speed. Ensure that the acceleration is less than or equal to  $0.1g$ .
- During the lifting operation, stop the operation immediately if abnormal noises, deformation, or welding cracking occur.



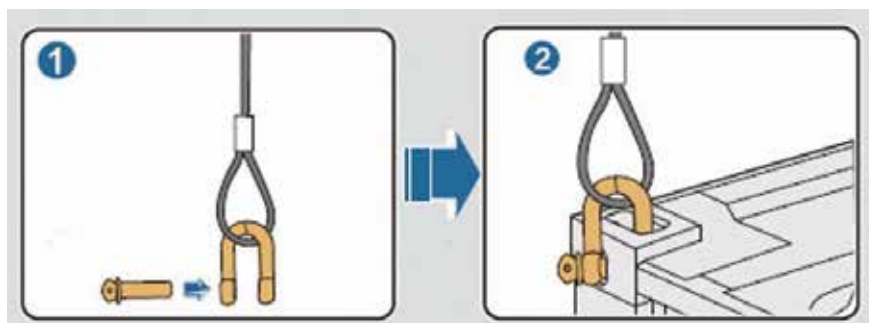

Figure 6-8: Crane lifting

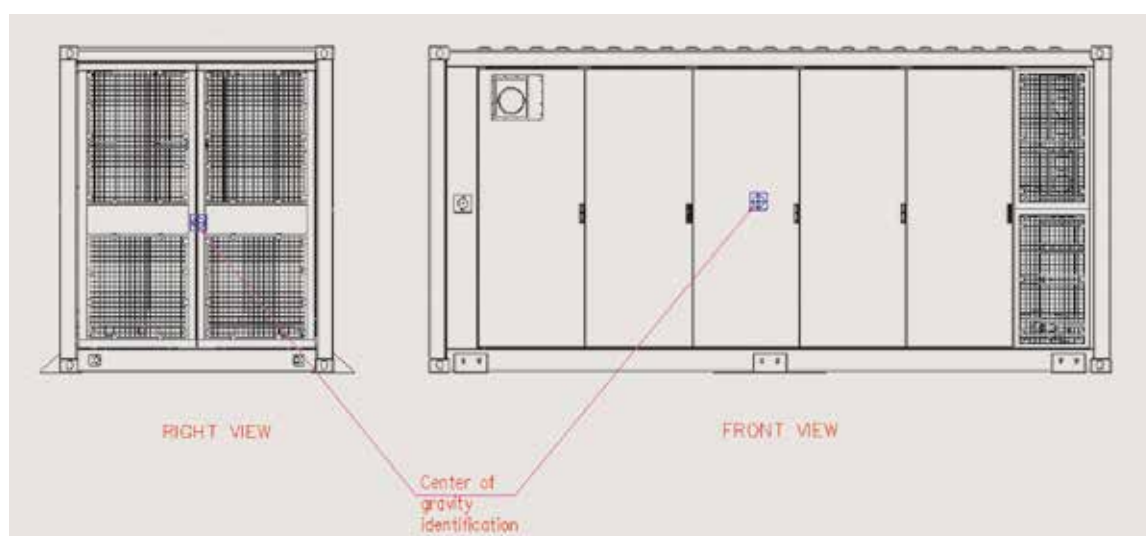

Figure 6-9: Center of gravity (for reference only)

## 6.4 INSTALLATION STEPS

### 6.4.1 DEVICE FIXATION

Before hoisting equipment, use a gradienter to measure the levelness of the foundation and ensure that the levelness of the foundation is less than 5mm. If the levelness is greater than 5mm, make necessary adjustment. After the foundation level is adjusted, place the container in the correct position, and then install and secure it. The steps are as follows:

**STEP 1:** After the container lands, use a gradienter to measure the levelness of the four corner fittings. The levelness must be less than 5mm. If the levelness is greater than 5mm, use stainless steel gaskets for leveling. After leveling, open and close all the container doors to ensure that they can be opened and closed smoothly. If the door cannot be opened and closed smoothly, adjust the container again to ensure that all doors can be closed and closed properly.

**STEP 2:** Determine the positions of expansion bolt holes and drill holes to bury M16X100 expansion bolts. Fix the L-brackets on the foundation, a single container requires

6 L-brackets. Tighten the L-brackets to the container with M16X50, A4-70 bolt assembly.

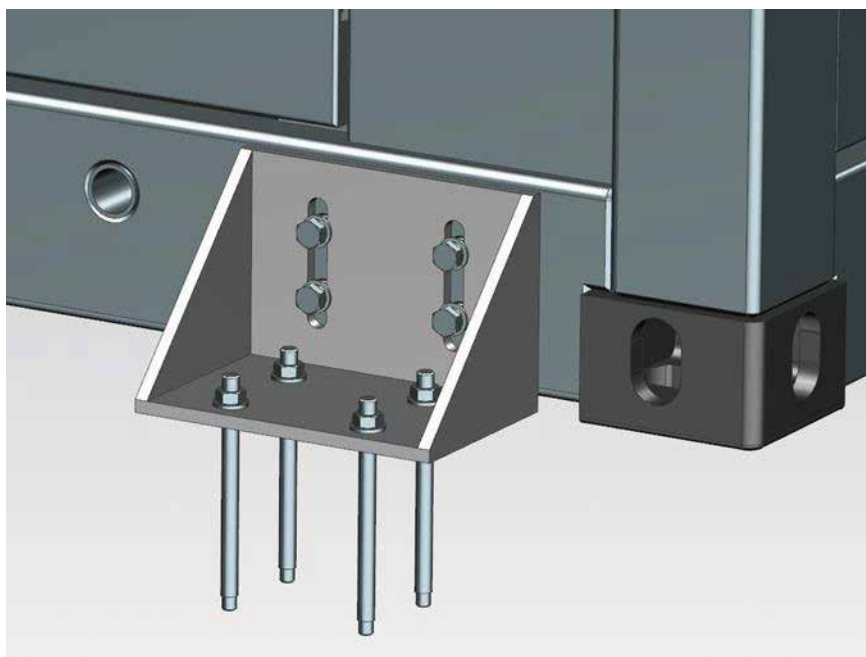
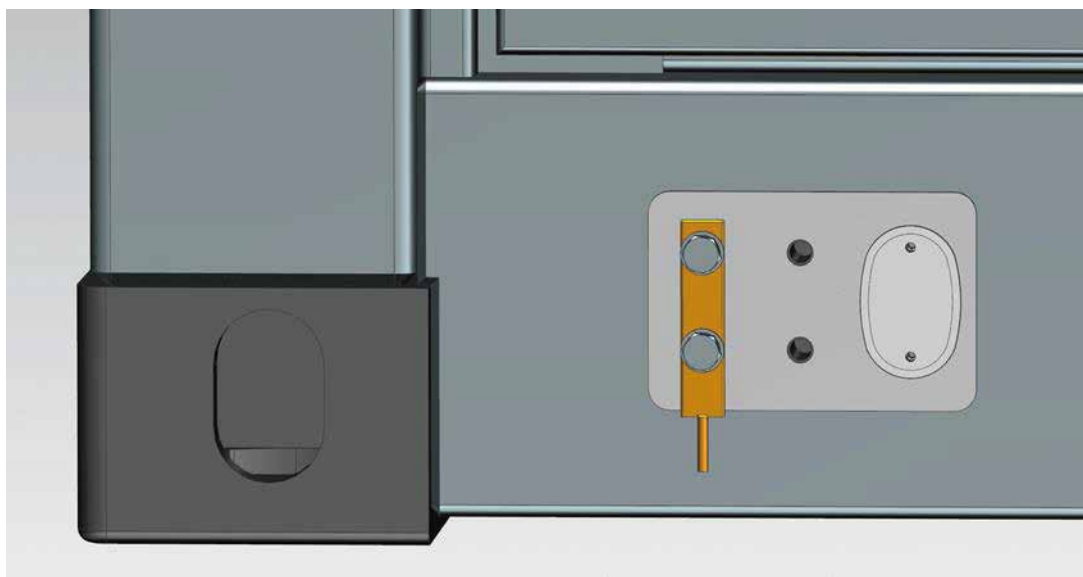

Figure 6-10: Install L-brackets

#### 6.4.2 DEVICE GROUNDING

Both the front and rear of the device have 2 grounding points. Select one grounding point based on site requirements. Each grounding point has 4 tightening points in total which are distributed in two rows and two columns. You can flexibly arrange ground cables horizontally or vertically according to the actual situation. The steps are as follows:

STEP 1: Make ground cable: CL250-12-2D double-hole copper nose is recommended. It is recommended to crimp ground cables or ground flat steel with a cross-sectional area of no less than 250mm<sup>2</sup>. Tighten the grounding cable with M10X30, A4-70 bolt assembly.



Vertical connection

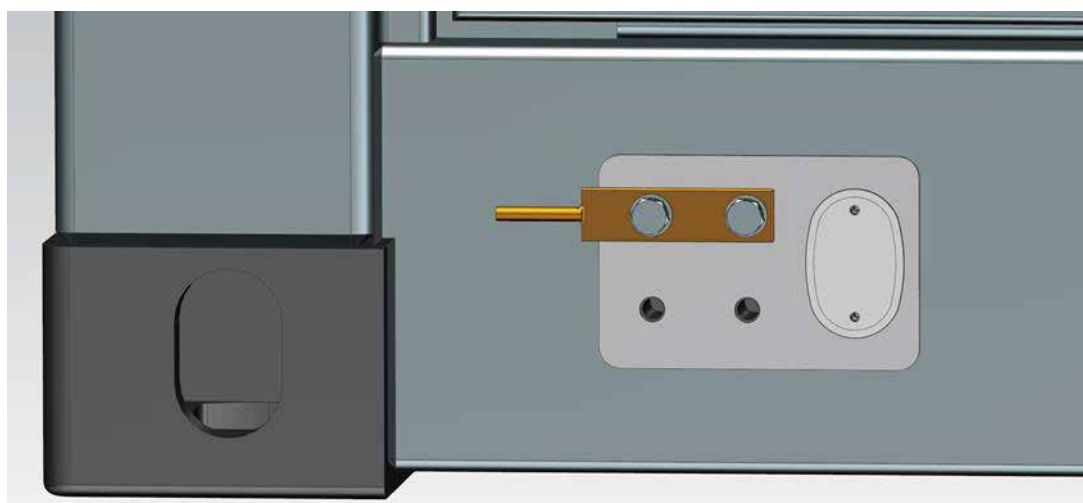

Horizontal connection

Figure 6-11: Install grounding cables.

### 6.4.3 WATER FIRE SUPPRESSION PIPE CONNECTION

There is a 2.5"NPSH external thread water fire suppression pipe coupling near the right end of BCP and 1300mm away from the bottom corner fitting. You can determine whether to install a fire hose in advance according to the actual situation.

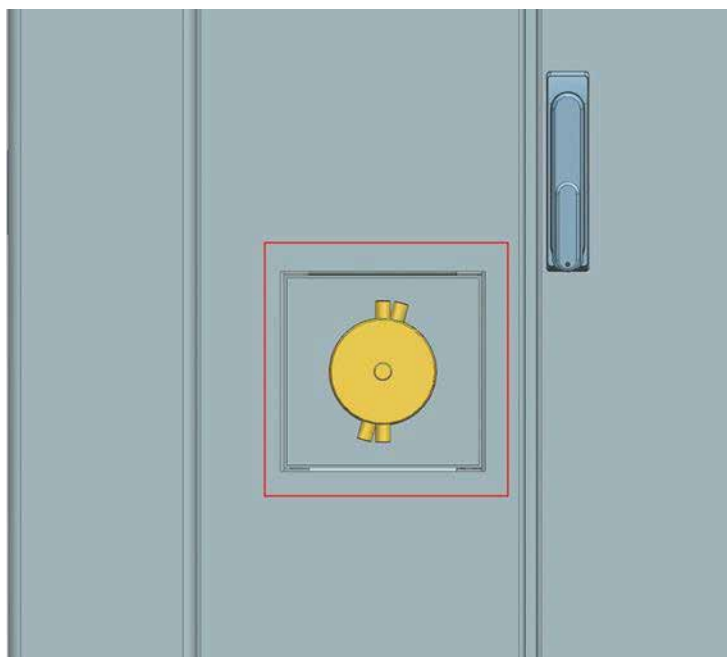



Figure 6-12: Water fire suppression pipe coupling

## 7 ELECTRICAL CONNECTION

### 7.1 PREPARATION FOR INSTALLATION

Tools for electrical connections are listed in the table below.

	WARNING
	<p>THE TOOLS USED FOR BATTERY POWER CONNECTION INSTALLATION SHOULD BE INSULATED OR SHOULD HAVE A MINIMIZED EXPOSED METAL AREA. AT LEAST THE GRIP PART SHOULD BE INSULATED.</p>





	IMPORTANT
	<p>BECAUSE OF THE STRUCTURAL PARTICULARITY OF THE CABINET TERMINAL BOARD, A SLEEVE SCREWDRIVER TOOL IS USED TO CONNECT.</p>

Table 7-1: Tools for electrical connection

NO.	ITEM	PURPOSE	SAMPLE
1	Cutter	Unpacking	
2	Insulated Torque wrench	Use to install power connection	
3	Insulated driver	Use to install power connection	
4	Multi-meter	Voltage measurement	



5 Insulation gloves Battery power connection



6 Wrench set Busbar connection



## 7.2 SYSTEM ELECTRICAL CONNECTION



### DANGER

IN THE EVENT OF A GROUND FAULT, COMPONENTS CONSIDERED VOLTAGE-FREE IN THE ENERGY STORAGE SYSTEM MAY CARRY LETHAL HIGH VOLTAGE WHICH IS POTENTIALLY LETHAL. THE DANGER OF ACCIDENTAL TOUCH EXISTS. BEFORE DOING ANY OPERATION, MAKE SURE THAT THE GROUNDING SYSTEM IS NOT FAULTY AND TAKE ADEQUATE PRECAUTIONS.



### CAUTION

ELECTRICAL CONNECTIONS ARE MADE ONLY BY PROFESSIONAL ELECTRICIANS AND QUALIFIED PERSONNEL. STRICTLY FOLLOW THE EQUIPMENT INTERNAL WIRING IDENTIFICATION FOR CABLE CONNECTION.



### WARNING

ENSURE THAT ALL DC AND AC SWITCHES IN THE PCS ARE DISCONNECTED BEFORE STARTING ELECTRICAL CONNECTIONS.



### CAUTION

THE VOLTAGE RATING OF THE SELECTED CABLE SHALL NOT BE LESS THAN THE PCS THREE-PHASE INSTANTANEOUS ALTERNATING VOLTAGE. THE VOLTAGE LEVEL OF THE DC CABLE SHOULD NOT BE LOWER THAN THE MAXIMUM DC VOLTAGE OF A LITHIUM BATTERY.



**WARNING**

WHEN CONDUCTING ELECTRICAL CONNECTIONS, CHECK THAT ALL CABLES ARE INSULATED AND INTACT. PARTIALLY EXPOSED OR OTHER DAMAGED CABLES OR INSULATED CABLES MAY POSE A SERIOUS SAFETY RISK AND SHOULD BE REPLACED IMMEDIATELY.



**CAUTION**

FAILURE OF EQUIPMENT OR SYSTEMS RESULTING FROM A VIOLATION OF THE INSTALLATION AND DESIGN REQUIREMENTS SPECIFIED IN THIS MANUAL WILL RENDER THE QUALITY ASSURANCE INEFFECTIVE.

### 7.2.1 AUXILIARY POWER CONNECTION INTERFACE

As shown in the following figure, connect the A, B, and C terminals according to the marks on the copper bars. Cables with a diameter larger than 3\*2AWG and CL38-10-2D double-hole copper nose are recommended.

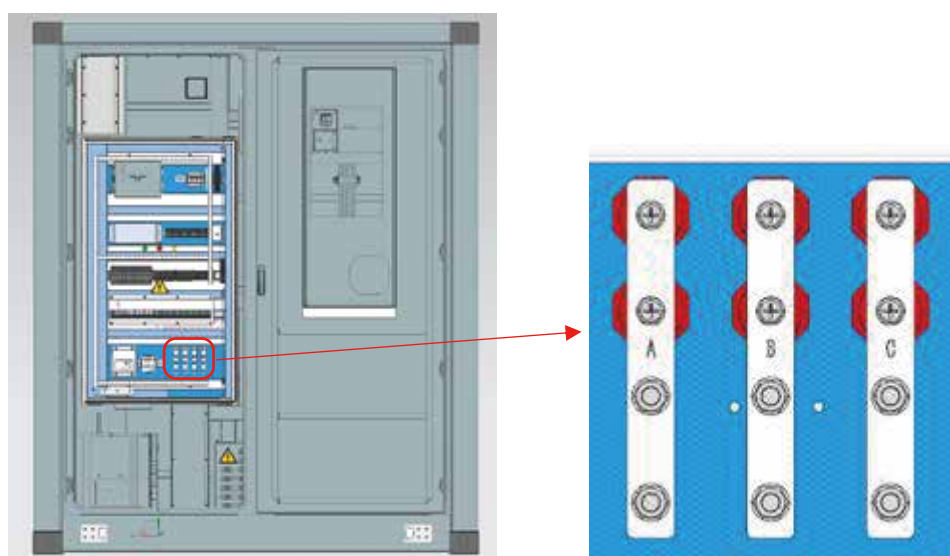

Figure 7-1: BCP auxiliary power supply copper bar

### 7.2.2 RESERVED PCS DRY CONTACT INTERFACE

As shown in the following figure, XT5-18, XT5-19, and XT5-20 are reserved as PCS normally closed and normally open dry contact interface (stop signals). Connect them according to the actual conditions of PCS. 1.0mm<sup>2</sup> cables and ET1.0-12 terminals are recommended.

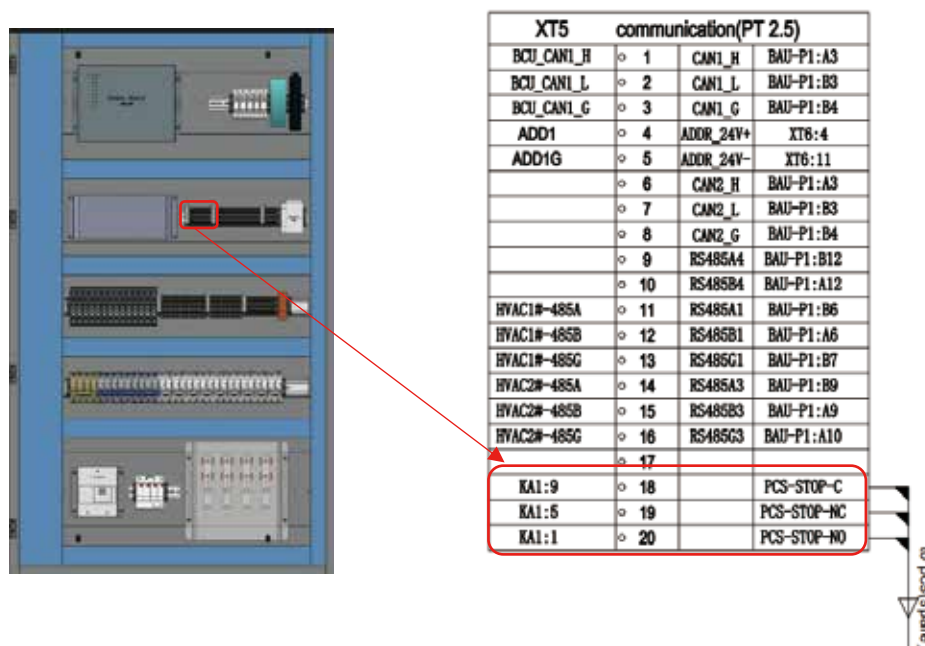

Figure 7-2: PCS reserved dry contact for emergency stop.

### 7.2.3 PCS POWER CABLE INTERFACE

As shown in the following figure, connect PCS1+, PCS1-, PCS2+, and PCS2- respectively. You are advised to use single-stage cables with a diameter larger than 5\*4/0AWG. PCS connection points are M12 double-row through holes.

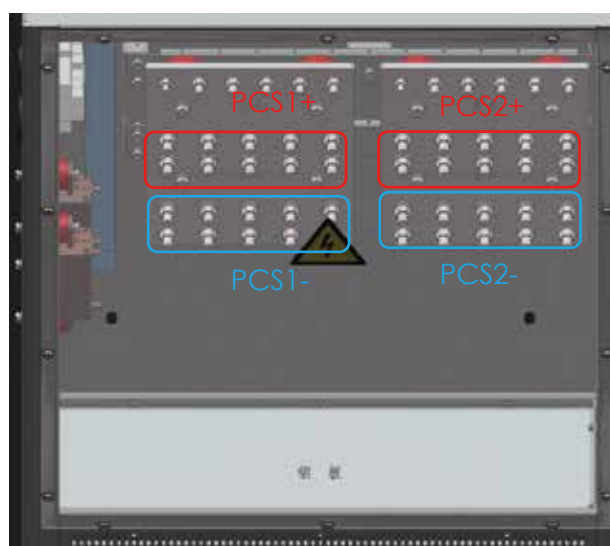

Figure 7-3: The BCP copper bars to PCS

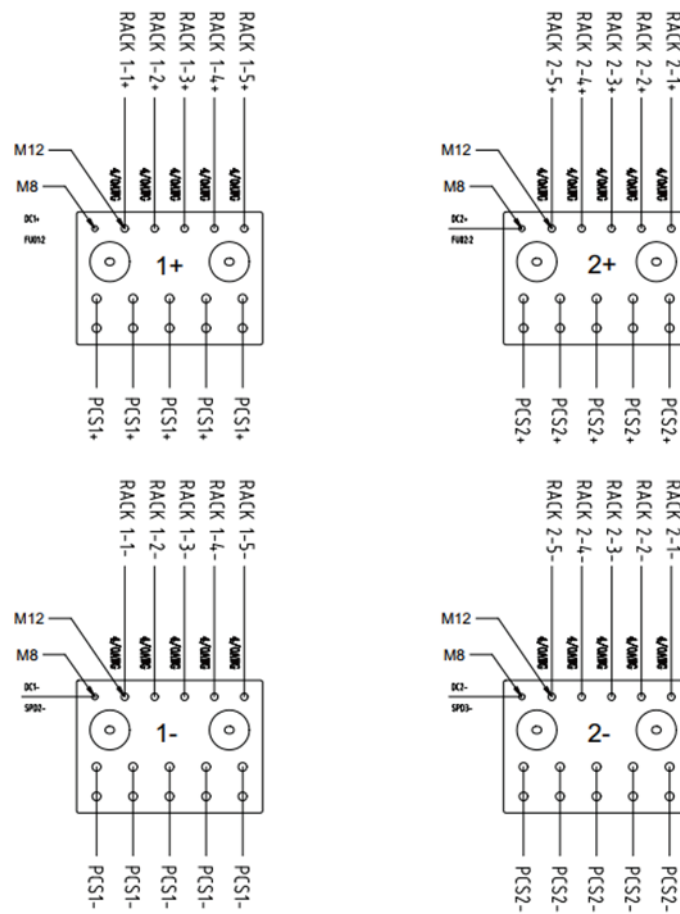

Figure 7-4: BCP wiring

### 7.3 DC SWITCHGEAR AND PACK DESCRIPTION

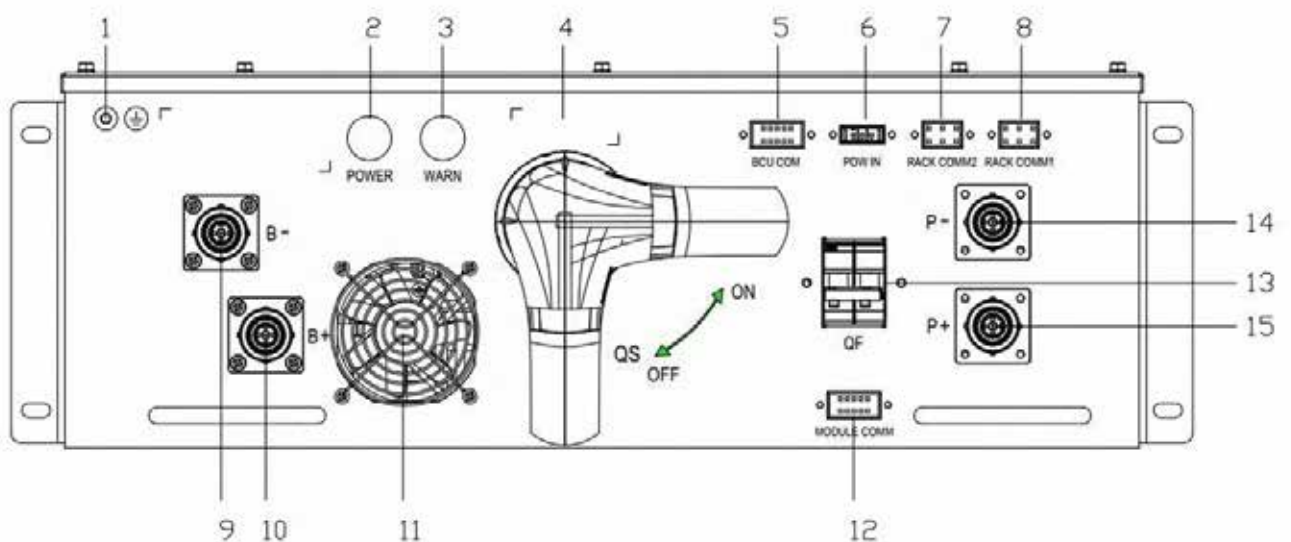

Figure 7-5: DC switchgear interface

Table 7-2: Interface Connectors of DC Switchgear

No.	Item	Function	Description
1		Grounding point	Grounding
2	POWER	Power indicator	Battery Rack power indicator
3	WARN	Fault indicator	Battery Rack fault indicator
4	QS	Break Switch	To connect and cut off the main circuit in
5	BCU COM	BCU communication	Debugging only
6	PWR IN	Aux power in	BMS 220Vac Aux power in
7	RACK COMM 2	Rack communication	Connect to the next COMM1
8	RACK COMM 1	Rack communication	Connect to the next COMM2
9	B-	Battery Negative	Connect to the highest module -
10	B+	Battery Positive	Connect to the highest module +
11	FAN	DC switchgear cooling fan	DC switchgear cooling fan
12	MODULE COMM	Module communication	BCU & BMU communication
13	QF	power switch	Power control of PWR IN
14	P-	PCS Negative	Connect to DC bus -
15	P+	PCS Positive	Connect to DC bus +

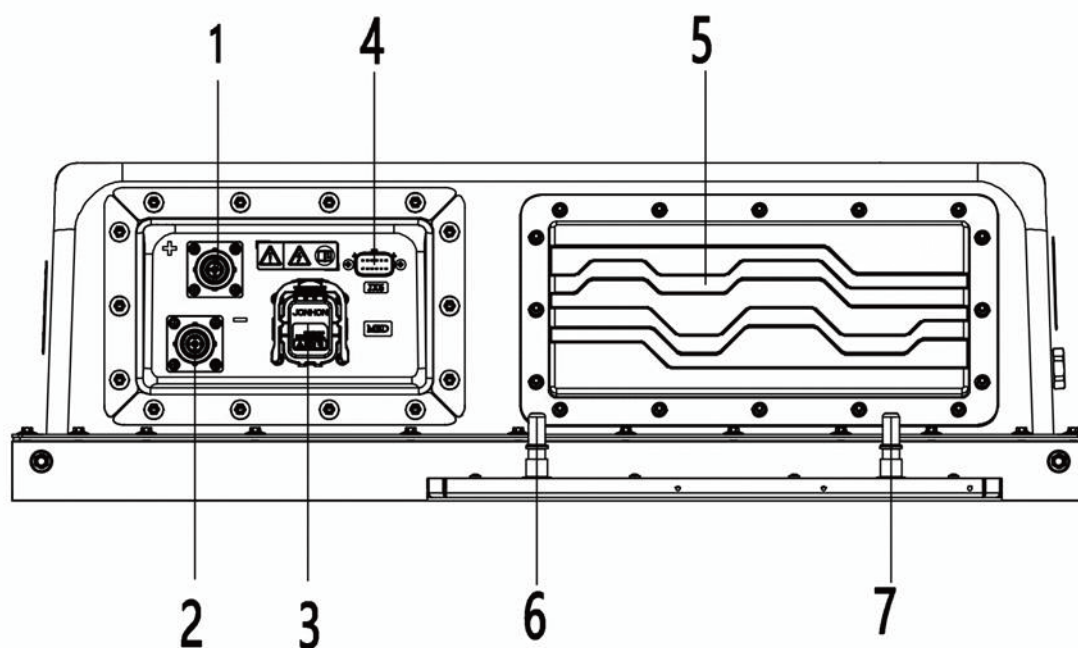

Figure 7-6: PACK interface

Table 7-3: Interface Connectors of PACK

No.	Item	Function	Description
1	+	Battery Positive	Battery Positive
2	-	Battery Negative	Battery Negative
3	MSD	Manual maintenance switch	MSD manual maintenance switch
4	JX6	BMU communication power supply	Including 24V power supply, CAN communication
5	BMU	BMU	Battery voltage and temperature collection, data reporting
6	Water inlet	PACK water inlet	/
7	Water outlet	PACK water outlet	/

## 8 COMMISSIONING

After checking all wiring points, make sure the wire harness is not missing or loose. All personnel are forbidden to touch any original device and metal part before power-on operation. Keep a safe distance from the container.

When powering on the device for the first time, professionals must set the parameters correctly. Incorrect Settings may affect the normal operation of the device.

### 8.1 PRE-COMMISSIONING OF BCP

To ensure the long-term reliable and safe operation of your energy storage system, please read and follow the instructions carefully.

[Note] ZOE is not responsible for battery damage and other losses caused by using it not per the specified requirements or using it beyond the specified range. Put into use chapter.

#### 8.1.1 CABLE CONNECTION CONFIRMATION

After checking all wiring points, ensure that the cables are not missing or loose. Do not touch any original equipment or metal parts before powering on. Keep a safe distance, connection terminals are connected tightly and reliably.

Please check the following items carefully before starting.

Table 8-1: Check list

NO.	ITEM
1	All electrical connections must be made in accordance with this manual.
2	The container enclosure is grounded and the protective cover inside the device is securely installed.
3	The system stop button is in the normal state.
4	All AC circuit breakers in the BCP are disconnected, that is, in the "OFF" position.
5	The DC switchgear low-voltage power switches of all battery RACKs are in the "ON" position.
6	The DC switchgear disconnecting switches of all battery RACKs are in the "ON" position.
7	All PACK MSDs are inserted and locked properly.

#### 8.1.2 MCB

Table 8-2: MCB0~MCB12

MCCB	MCB0	MCB1	MCB2	MCB3	MCB4	MCB5	MCB6
Main switch on	SPD1	380V power	Air Cooled Chiller1#	Air Cooled Chiller2#	Socket	UPS	Automatic switchover

MCB7	MCB8	MCB9	MCB10	MCB11	MCB12
AC/DC	BMS power supply	FSS power supply	Exhaust Fan	BCP-HVAC	Spare

## 8.2 POWER-ON PROCEDURES

### 8.2.1 POWERING ON THE AUXILIARY POWER SUPPLY

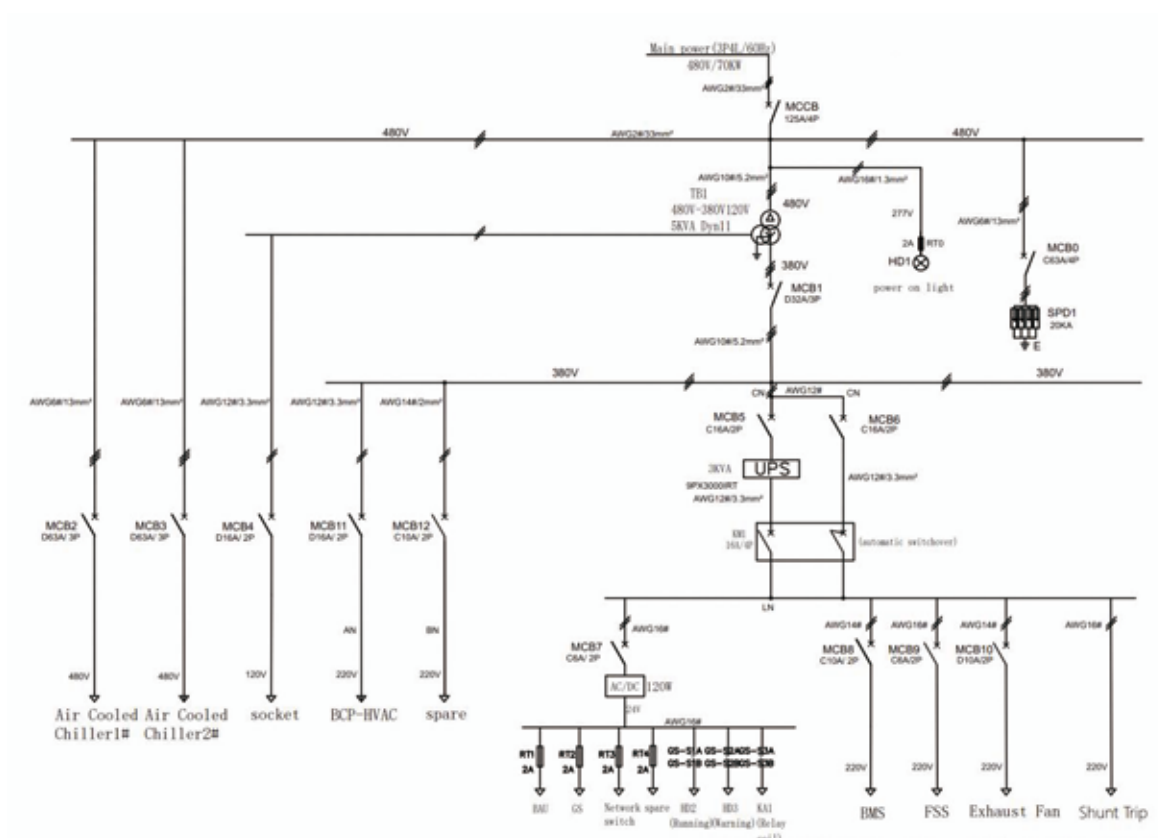

Figure 8-1: Auxiliary connection (for reference only)

Perform the following steps to power on the auxiliary power supply. Keep all the doors closed when the auxiliary power supply and DC battery are not in operation and maintenance mode; otherwise, the auxiliary power supply and DC battery will be forcibly powered off. Use the UPS cold start for the first power-on as shown in figure 8-2 (This change is automatically restored to the normal mode after the GS is powered off).



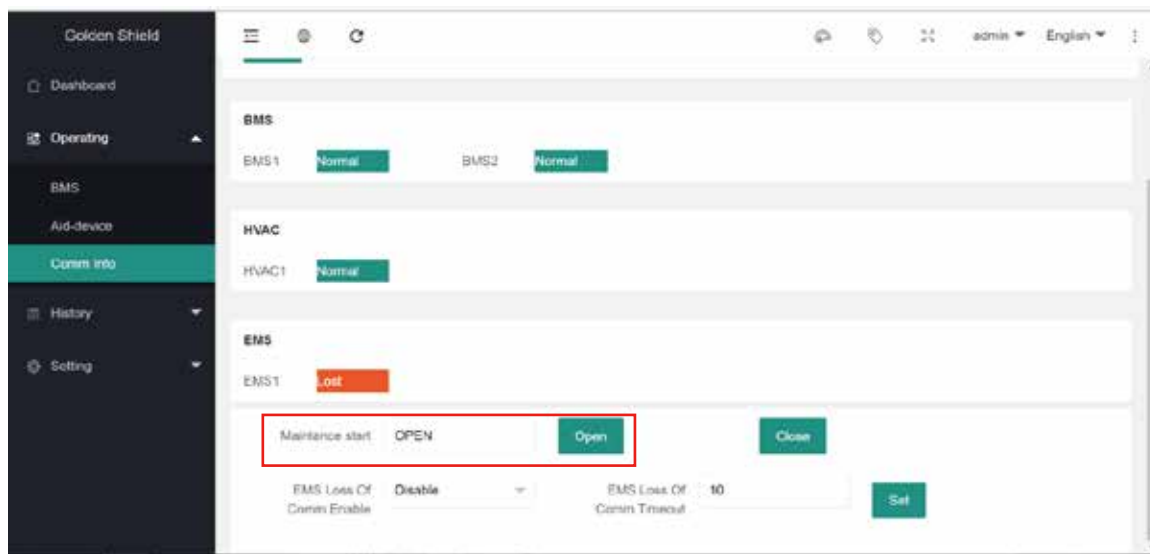

Figure 8-2: GS-web operation and maintenance mode switch

STEP 1: Press the <ON/Mute> button on the front panel of the UPS to start the fan and display the default UPS status screen. Press and hold the <ON/Mute> button for 3 seconds. The UPS buzzer rings for 1 second. Then the UPS is successfully started.

STEP 2: Close MCB7, AC/DC power supply, DC24V normal output, GS, switch, BAU and other devices power supply is completed.

STEP 3: Use a network cable to connect the PC to the GS-web port of the container or the switch in the BCP, access the GS web terminal, and change the GS mode to operation and maintenance mode (exit the operation and maintenance mode after normal operation).

STEP 4: After the 480V 3P3L power supply is connected normally, close the MCCB 480V power supply switch, and the transformer will work normally, and convert the AC480V to AC380V/AC120V at the same time.

STEP 5: Close MCB0 AC surge protector switch to ensure that the AC surge protector works properly.

STEP 6: Close MCB5 UPS main power switch. The UPS power supply is normal, and the UPS mode is switched to the mains electricity mode.

STEP 7: Close MCB6 UPS bypass switch to automatically switch to the bypass mode through the KM1 contactor when the UPS is abnormal.

STEP 8: Close MCB8 BMS power switch, and the AC power supply to the BMS is

normal (the power indicator of the DC switchgear is green).

STEP 9: Open the fire suppression host, connect the 24V backup power, and close MCB9 fire suppression power switch, the fire suppression host power supply is normal.

STEP 10: Close MCB10 fire suppression fan switch, and the fan power supply is normal.

STEP 11: Close MCB2, MCB3 and MCB11, and then HVAC1#~HVAC3# will run automatically after power supply.

STEP 12: Close MCB4 maintenance socket power switch the container maintenance socket power supply is normal.

## 8.2.2 POWERING ON AND OFF THE HVDC

After the auxiliary power supply is normally powered, energy storage system information overview (figure 8-3) and the running status of all RACKs (figure 8-4) and HVACs (figure 8-5) can be normally viewed on the GS-web terminal.

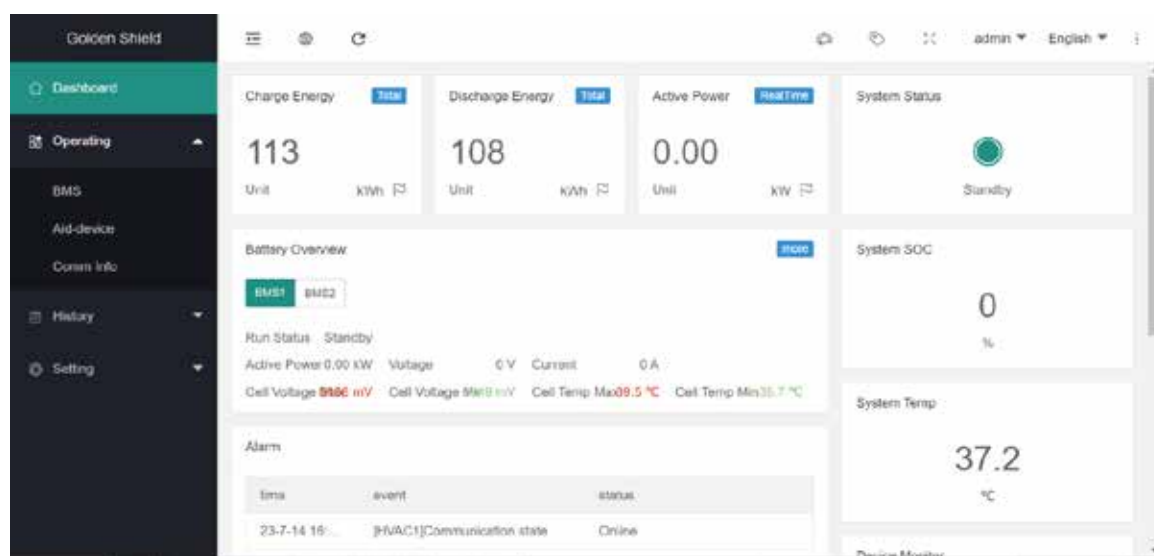

Figure 8-3: Energy storage system information overview

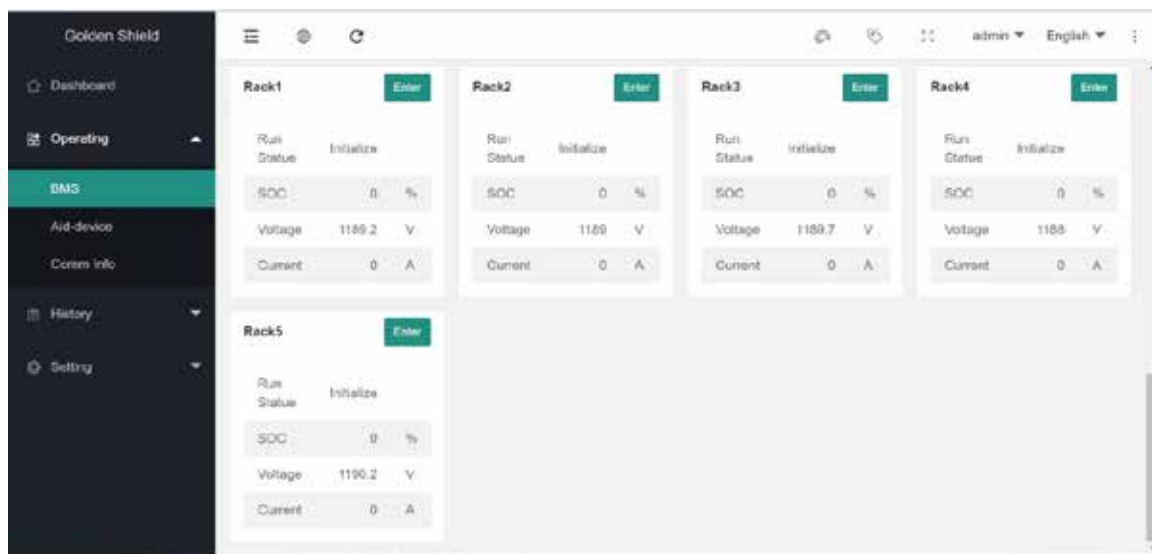

Figure 8-4: RACK information interface

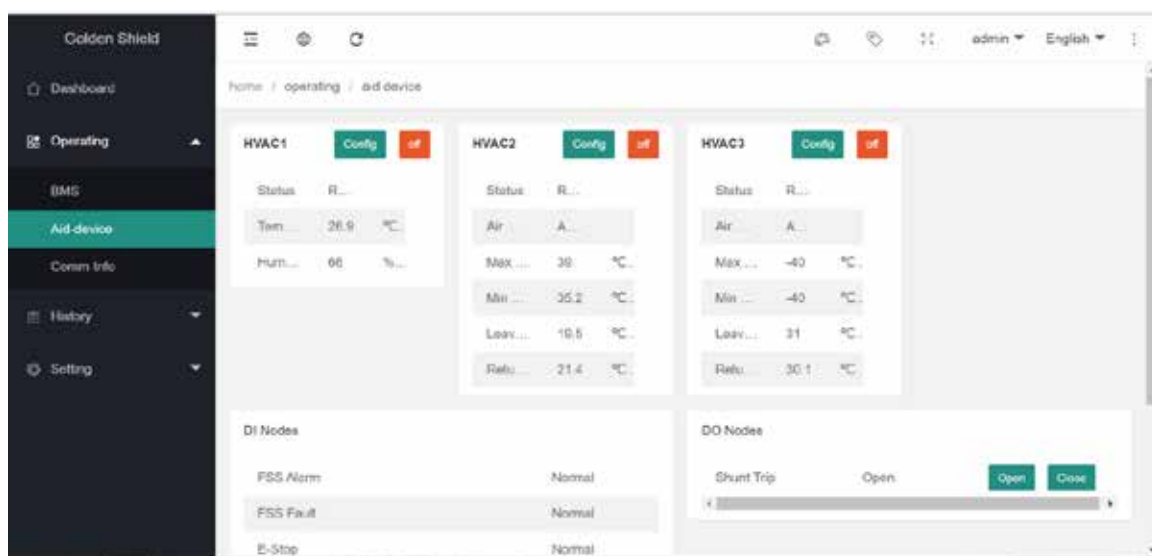

Figure 8-5: HVAC and other auxiliary equipment information

After the GS-web port of the container is connected to the web terminal, the HVDC can be powered on and off, and the powering on of the PCS DC side is completed. After the communication is normal, you can power on and off HVDC of RACK 1# and 2# using the command or the GS-web terminal (as shown in figure 8-6 and figure 8-7). After the contactors of all RACK DC switchgears are closed, the DC side is powered on. Then charge and discharge power of PCS1/2 can be delivered as required.

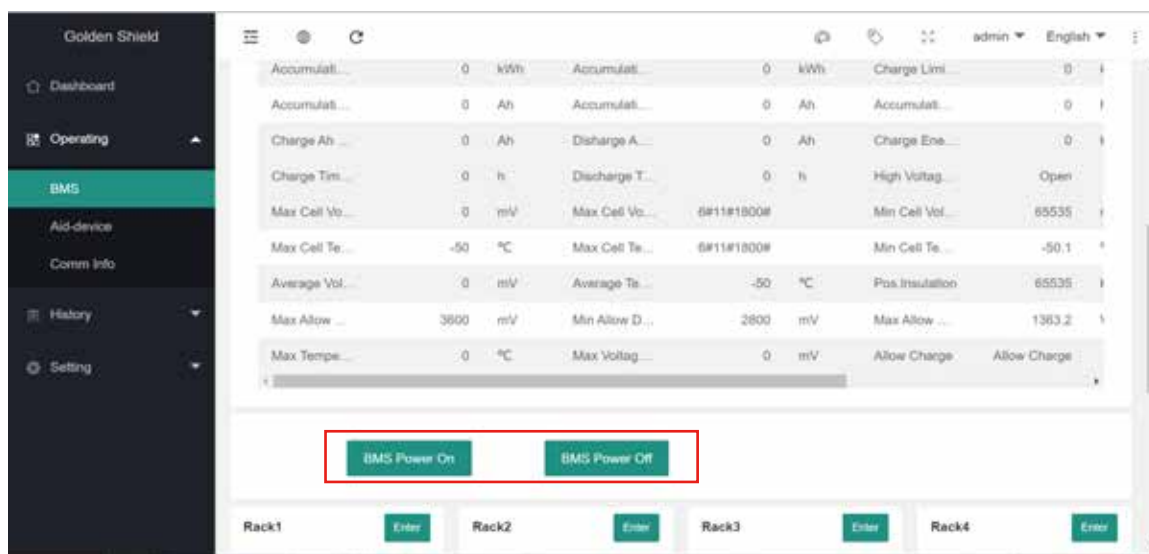

Figure 8-6: BMS real-time running information

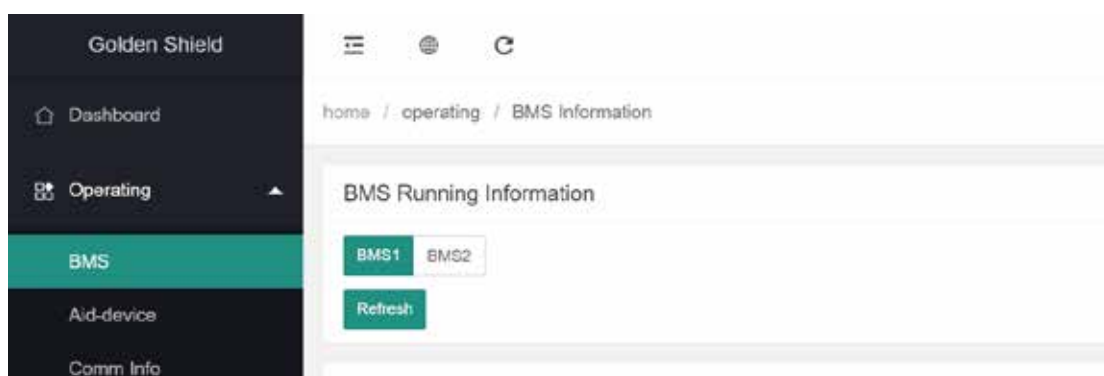

Figure 8-7: BMS1, BMS2 switchover

Note1: Do not manually power off the energy storage system during charging and discharging. Otherwise, contactors or isolation switches may be damaged.

Note2: When the charge and discharge terminal or the BMS system fails, the BMS will implement the charge current limiting strategy according to the fault level, and send the current limiting value to the PCS, the PCS will adjust the charge and discharge power in real time.

## 8.3 POWER-OFF PROCEDURES

### 8.3.1 POWERING OFF THE AUXILIARY POWER SUPPLY

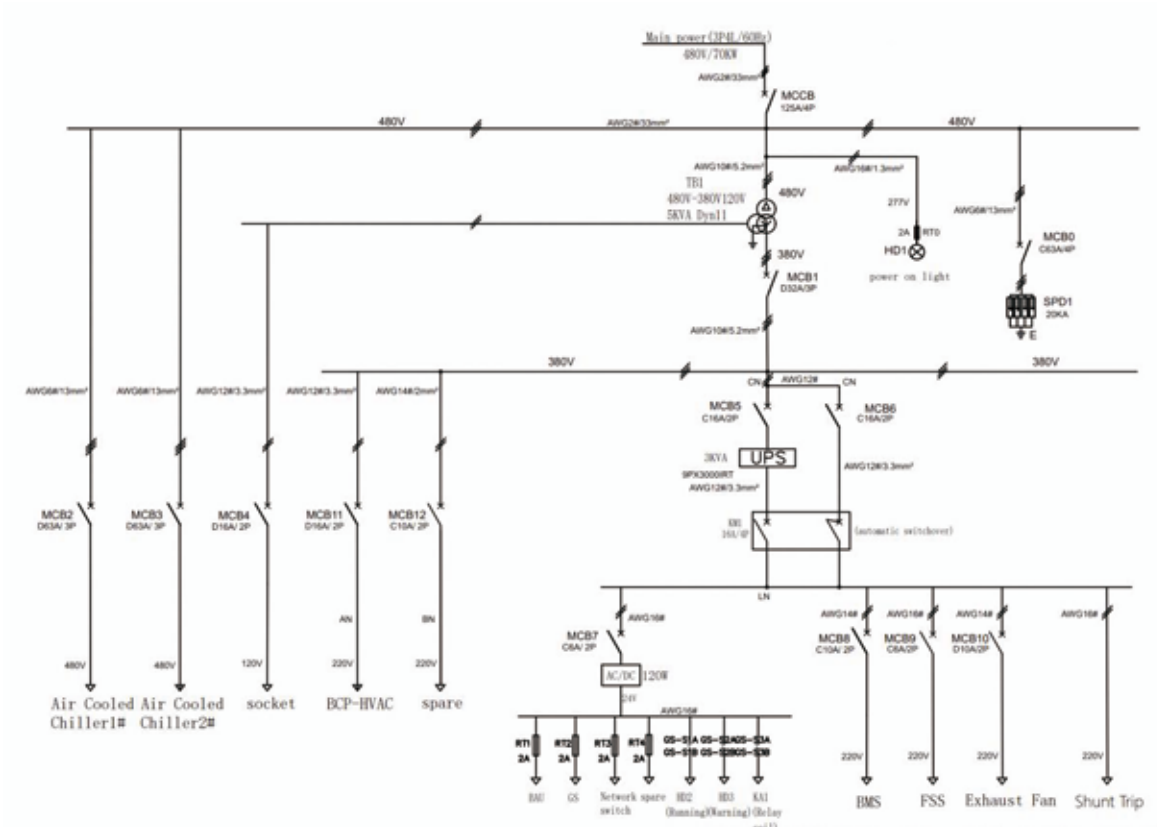

Figure 8-8: Auxiliary connection (for reference only)

STEP 1: Disconnect MCB4, MCB11, MCB3, MCB2, MCB10 in sequence.

STEP 2: Disconnect MCB9, disconnect the 24V backup power.

STEP 3: Disconnect MCB8, MCB6, MCB5, MCB0 in sequence.

STEP 4: Disconnect MCCB, disconnect the 480V 3P3L power supply.

STEP 5: Disconnect MCB7.

STEP 6: Shut the UPS down and stop the fan.

## 9 OPERATION

### 9.1 SYSTEM OPERATION

To ensure the long-term safe and reliable operation of your energy storage system, please read and follow the instructions below:

	<p style="text-align: center;"><b>NOTE</b></p> <p>OUR COMPANY WILL NOT BE LIABLE FOR ANY DAMAGE CAUSED BY FAILURE TO USE THE BATTERY SYSTEM IN ACCORDANCE WITH THE SPECIFIED REQUIREMENTS OR BEYOND THE SPECIFIED RANGE AND OTHER LOSSES ARISING OUT OF SUCH DAMAGE.</p>
---	--

#### 9.1.1 TEMPERATURE CHARACTERISTICS

- Operating ambient temperature: -30 °C ~50 °C. If stored in a cold environment (e.g. 0 °C) before installation, it will take some time to heat up before it can be recharged.
- Optimum operating ambient temperature: 0 °C ~45 °C. When the ambient temperature is higher than 45 °C or lower than 0 °C, the battery charging and discharging power decreases.
- Safe storage ambient temperature: -30 °C ~60 °C.
- Recommended storage environment temperature: 20°C~30°C.

#### 9.1.2 CABLE CONNECTION CONFIRMATION

- Before power on, check the connection cable of the whole system, and make sure that the cable connection is reliable without aging fracture and insulation damage.
- Check whether the positive and negative poles of the DC output power cable in the container are connected correctly.
- Check whether the power connection of the container is correct.
- Check whether all communication wires and cables and sub connections at the connection ends are tight and reliable.

Refer to Section 7.3 for details of DC switchgear.

## 10 MAINTENANCE

To ensure the safety and the life span of the Battery Energy Storage BESS (BESS), proper maintenance is needed and necessary. ZOE provides the Scheduled Maintenance Program (SMP) for up to 10 years for its BESS products, which will bring you trouble-free revenue generation. Cost adder, terms, and conditions apply for SMP.

### 10.1 PRECAUTIONS

	<p style="text-align: center;"><b>DANGER</b></p> <p>WHEN THE DEVICE IS RUNNING, THE HIGH VOLTAGE MAY CAUSE AN ELECTRIC SHOCK, WHICH MAY RESULT IN DEATH, PERSONAL INJURY, OR PROPERTY DAMAGE. THEREFORE, BEFORE PERFORMING ANY MAINTENANCE, POWER OFF THE DEVICE AND STRICTLY FOLLOW THE SAFETY PRECAUTIONS LISTED IN THIS MANUAL AND OTHER RELATED DOCUMENTS</p>
---	---

- Maintain the device when you are familiar with the contents of this manual and have appropriate tools and test devices.
- Before performing maintenance, power off the device, and then wait for the appropriate time according to the instructions on the delayed discharge label. Ensure that the device is powered off.
- During the maintenance process, avoid irrelevant personnel entering the maintenance site. Temporary warning signs or fences must be erected for isolation.
- If the device fails, please contact our after-sales service in time.
- Power on the device only after the fault is rectified. Otherwise, the fault may expand or the device may be damaged.
- Do not open the device without authorization, otherwise there will be a risk of electric shock, and the resulting failure is not covered by the warranty.
- Operation and maintenance personnel and technical professional should be fully trained in the safe use and maintenance of the device, and operate with adequate precautions and equipped with personal protective equipment.
- When you need to move or reconnect cables, cut off the power input. After the internal energy is completely out and using a multimeter to ensure that there is no dangerous voltage of the DC bus and the parts inside the machine to be repaired,

the maintenance can be started.

- Battery maintenance should be performed or supervised by a personnel familiar with the battery and its required precautions.
- When replacing a battery, replace it with the same type of battery or battery pack.
- Check immediately after the maintenance operation to ensure that there is no tool or any other part left inside the device.
- If you do not use the device for a long time, store batteries and recharge them according to this manual

## 10.2 BATTERY OPERATING TERMS AND OPERATING INSTRUCTIONS

### 10.2.1 TERMS EXPLANATION

Table 10-1: Terms Explanation

TERM	EXPLANATION
<b>Normal operating</b>	Refers to the system that works every day.
<b>Intermittent operating</b>	Refers to a system that does not have a fixed monthly running frequency and cannot guarantee daily work.
<b>Long-time unused</b>	The battery system has not started working for more than 6 months (the battery system needs to be charged to 40% SOC before being suspended).

### 10.2.2 OPERATING INSTRUCTIONS

Table 10-2: Operating Instructions

TERM	INSTRUCTION
<b>Normal operating system</b>	<ul style="list-style-type: none"> <li>➤ Perform battery maintenance on the system every twelve months to prevent battery damage. Refer to 10.4~10.8 for specific maintenance operating methods.</li> <li>➤ Inspect ESS every twelve months and make inspection record.</li> </ul>
<b>Intermittent operating system</b>	<ul style="list-style-type: none"> <li>➤ The operating instructions are the same as those of a normal operating system.</li> </ul>
<b>Long-time unused system</b>	<ul style="list-style-type: none"> <li>➤ SOC range of battery storage: 30%~50%., avoid long-term storage of batteries below 15% SOC. If the battery is not used for a long time, it is necessary to cut off the power-consuming equipment in time.</li> <li>➤ Perform battery maintenance on the system every three months to prevent battery damage. Refer to <a href="#">Section 10.3</a> for specific maintenance operating methods.</li> <li>➤ Before the first usage of a long-time unused system, the battery system must be fully charged at least once to activate the battery system to recover the battery</li> </ul>



performance to the best condition.

Tips: If the energy storage system is not used for a long time, it will cause irreversible damage to the battery. Please perform regular maintenance.

### 10.3 OPERATING METHOD OF BATTERY MAINTENANCE

To ensure the long-term safe and reliable operation of your energy storage system, please read and follow the instructions below.

Table 10-3: Operating Method of Battery Maintenance

PLAN	MAINTENANCE PROCESS
<b>Plan 1 This plan is applicable when the SOC of the battery system is low(&lt; 50%)</b>	1. Discharge the battery system to the cut off condition(Average cell voltage $\leq 3.1V$ or the lowest cell voltage $\leq 2.8V$ ), then stop discharging, standing for 1 hour. 2. Fully charging the battery system (The highest cell voltage $\geq 3.6V$ ), after charging, standing for 1 hour. 3. Discharge the battery system to 40% SOC and stop.
<b>Plan 2 This plan is applicable when the SOC of the battery system is high(&gt; 50%)</b>	1. Fully charging automatically to the battery system (The highest voltage $\geq 3.6V$ ), after charging, standing for 1 hour. 2. Discharge the battery system to the cut-off condition (Average cell voltage $\leq 3.1V$ or the lowest voltage $\leq 2.8V$ ), then stop discharging, standing for 1 hour. 3. Charge the battery system to 40% and stop.

Tips: 1. Check to ensure environmental safety, system safety, no alarm, no-fault before performing battery maintenance operations.

2. Customer can perform the battery maintenance by charging/discharging the container directly without connecting BCP.

## 10.4 VISUAL INSPECTION

Table 10-4: Visual Inspection

NO.	MAINTENANCE WORK	INTERVAL
<b>Power Conversion System (PCS) / Energy Storage Inverter</b>		
1	Check all the labels and nameplates of the PCS enclosure(s).	12 months
2	Check the exterior of the enclosure for any signs of damage, metal fatigue, or vandalism. For signs of metal fatigue or rust, remove rust and coat with a rust protector. Paint over any vandalism.	12 months
3	Inspect all louvers for any signs of damage, metal fatigue, or vandalism. For signs of metal fatigue or rust, remove rust and coat with a rust protector. Paint over any vandalism.	12 months
4	Check door insulation is not damaged and does not stick to the door when opening. Also, verify all doors are sealed tightly when the handle is locked.	12 months
5	Inspect the interior of the PCS enclosure for any signs of damage, metal fatigue, and/or water damage, and/or spots and egress. For signs of metal fatigue or rust, remove rust and coat with a rust protector. Caulk any areas where water egress could or has occurred.	12 months
<b>Battery Enclosure</b>		
6	Check all the labels and nameplates on the battery enclosure(s).	12 months
7	Inspect the exterior of the enclosure for any signs of damage, metal fatigue, or vandalism. For signs of metal fatigue or rust, remove rust and coat with a rust protector. Paint over any vandalism.	12 months
8	Inspect all louvers for any signs of damage, metal fatigue, or vandalism. For signs of metal fatigue or rust, remove rust and coat with a rust protector. Paint over any vandalism.	12 months
9	Verify door insulation is not damaged and does not stick to the door when opening. Also, verify all doors are sealed tightly when the handle is locked.	12 months
10	Inspect the interior of BESSs for any signs of damage, metal fatigue, and/or water damage, and/or spots and egress. For signs of metal fatigue or rust, remove rust and coat with a rust protector. Caulk any areas where water egress could or has occurred.	12 months
<b>Batteries(normal or intermittent operation)</b>		
11	Inspect all battery management system(s) ("BMS") and battery switchgear.	12 months
12	Verify connections to BMS and battery switchgear are tight and solidly connected.	12 months
13	Inspect battery modules for any damage, rust, discoloration, condensation, or leakage. Repair or replace as needed.	12 months
14	Inspect battery power cables for any damage, rust,	12 months

	condensation, warping, or leakage. Repair or replace as needed.	
15	Inspect battery communication cables for any damage, rust, discoloration, condensation, warping, or leakage. Repair or replace as needed.	12 months
<b>Air-Conditioning Unit(s)</b>		
16	Inspect radiators and outer circulation outlet for any dust/sand blocks. Clean any blocks with water or a blower.	6 months
17	Inspect that the air conditioner fan blades are not damaged and that the rotating fan is smooth with no unusual noise.	6 months
18	Inspect the electrical cables and wiring terminals of the air conditioner to check whether they are loose	6 months
19	Inspect the condenser to ensure that it is not blocked by foreign bodies and the fins are not seriously bent or deformed.	6 months
<b>Fire Suppression System(s)</b>		
20	Inspect smoke detector. Open the cabinet door, turn on the power. if the temperature and smoke indicator flashing every few seconds, the smoke detector is working normally.	12 months
21	Inspect the battery in the fire suppression host, check whether the battery is normally charged, and whether the voltage is within the normal range	12 months
22	Inspect the inlet shutters and exhaust fans, and check whether they can be manually started and stopped	6 months
23	Inspect all pipe and cable connections for leakage, and repair as needed.	6 months

## 10.5 MECHANICAL INSPECTION

Table 10-5: Mechanical Inspection

NO.	MAINTENANCE WORK	INTERVAL
1	Inspect all anchoring bolts of PCS and battery enclosures that are securely fastened. Use a torque wrench to check any suspicious loosen, fasten, and mark as needed.	12 months
2	Verify the door and hinges of PCS and battery enclosures can move freely without restrictions and don't creak. Apply lubricant as necessary.	12 months
3	Verify locking mechanisms lock freely and properly without restrictions. Apply lubricant as necessary.	12 months
4	Torque check the bolts of AC and DC connections of PCS per ZOE recommended values in the BESS installation manual.	12 months
5	Verify connections to BMS and battery switchgear are tight and solidly connected.	12 months
6	Inspect all bolts or connectors on battery modules for	12 months

	any sign of loosening. Torque check the bolts of all connections per ZOE recommended values in the BESS installation manual.	
7	Check nuts and bolts. Torque bolts, bus joints, and cable terminals per BESS installation manual.	12 months
8	Check and clean/replace air filters. Ensure the air filter is clean and there is no visible damage. Scheduled cleaning of the air filter is necessary to reduce air blockage to maintain adequate ventilation. The Interval of air filter cleaning should be decided based on on-site conditions. More frequent cleaning may be required.	12 months

## 10.6 ELECTRICAL INSPECTION

Table 10-6: Electrical Inspection

NO.	MAINTENANCE WORK	INTERVAL
1	Inspect AC/DC capacitor casing for melting or signs of corrosion.	12 months
2	Inspect the DC disconnect knob for damage and ensure knob/handle functionality.	12 months
3	Inspect relay(s). If the relay casing is transparent, that exposes internal components. Look for burn marks or signs of premature failure. Otherwise, inspect the relay casing for visible damage.	12 months
4	Perform a visual inspection of the AC/DC sensors. Compare current reading from HMI against a known measurement (for example, measured by calibrated clamp meter). The current sensor can be calibrated from HMI. However, if the current reading is significantly different from the last calibration, it may indicate a compromised sensor.	12 months
5	Perform a visual inspection of temperature sensors.	12 months
6	Perform a visual inspection of the AC/DC filter modules.	12 months
7	Check surge protectors' condition by confirming the status of surge protector on the main circuit and control circuit.	12 months
8	Check for open fuse(s). Do so by inspecting the protected circuit, and if any damage is found, remove any fault condition that caused the burning or damage of the fuse initially before replacing the fuse and re-energizing the circuit.	12 months
9	Inspect wiring harnesses, connectors, and power cables for signs of damage. Inspect field fitted and installed cables for proper sealing. Inspect factory sealed connections. Damaged sealing may indicate unauthorized field modification. Perform a thermal scan on power cables and look for hot spots that indicate high resistance.	12 months
10	Inspect circuit boards, by checking ribbon cables and wire connectors are seated properly. Check for any sign of overheating.	12 months
11	Inspect fan operation, check all signs of wear and tear, and abnormal noise; ensure that fan works properly as per control signals.	12 months
12	Measure insulation resistance between battery (+) to ground and battery (-) to ground at the applied voltage for	12 months

	60 seconds. Troubleshoot for resistance value less than 30k ohms.	
<b>13</b>	Measure control voltage on circuit boards aligns with BESS manual specifications.	12 months
<b>14</b>	Check all fuse status, change any blown ones.	12 months

## 10.7 CONTROL INSPECTION

Table 10-7: Control Inspection

<b>NO.</b>	<b>MAINTENANCE WORK</b>	<b>INTERVAL</b>
<b>1</b>	Verify firmware version and update as required per ZOE's specifications.	12 months
<b>2</b>	Review all alarm, event, and fault logs as recorded on the HMI of PCS.	12 months
<b>3</b>	Review all alarm, event, and fault logs as recorded on the HMI of the FSS controller.	12 months
<b>4</b>	Check all communication features function properly.	12 months

## 10.8 SAFETY INSPECTION

Table 10-8: Safety Inspection

<b>NO.</b>	<b>MAINTENANCE WORK</b>	<b>INTERVAL</b>
<b>1</b>	Check all warning signs are clear and legible.	12 months
<b>2</b>	Check the emergency stop button's function.	12 months
<b>3</b>	Check all safety ground connections.	12 months
<b>4</b>	Check the functionality of the Fire Suppression System(s).	12 months

## 11 COMMON FAULTS AND TROUBLESHOOTING

The common faults and troubleshooting are as follows.

Table 11-1: Common faults and troubleshooting

NO.	Fault category	Fault description	Handling method
1	Air conditioner communication lost	The WEB interface displays a communication failure.	<p>Air conditioners in the BCP cabinet: check whether the 485-communication cable of the air conditioner is loose, and then check whether the communication cable is properly connected. (Connect the 485-communication cable A and B to the COMM1-A/B port on the Golden Shield controller and connect the shielded layer to the COMM1-G port.) Then check whether the IP addresses of air conditioners on the air conditioner panel are all 1.</p> <p>Liquid cooling unit 1/2: Check whether the 485-communication cable of liquid cooling unit 1/2 is loose, and then check whether the communication cable is correctly connected to BMS XT5-11 to XT5-16 (The addresses of liquid cooling units are divided into 1,2 by pile)</p>
2	Access control failure	After closing all the door, the WEB interface still shows that the cabinet door is open.	Check whether the limit switch on the cabinet door is fully closed, manually turn off the limit switch, and check whether there is a normally closed feedback signal connected to the GS local controller (GS-DI-4).
3	BMS communication failure	BMS data loss	<p>1. Check whether a 120Ω terminal resistor is inserted into the COMM2 port on container RACK2-1.</p> <p>2. Check whether the communication cables between the BCP and RACK1-1 COMM1 are properly connected. Then check whether the communication cables directly from RACK COMM2 to the next RACK COMM1 are properly connected.</p>
4	Air conditioner failure	Air conditioner power supply burned out due to overvoltage.	This problem occurs when the N wire in the system is in poor contact. As a result, the phase voltage increases by 1.732 times, resulting in overvoltage. Therefore, you need to check whether

			the N wire is reliably connected before powering on the air conditioner.
		Air conditioner power supply is normal but burns out after power on.	The internal communication board of the air conditioner is burned out, which is a quality problem of the air conditioner.
5	Fire failure	The fire controller indicates that the main power supply is faulty.	<ol style="list-style-type: none"> <li>1. Check whether the fire power supply switch MCB9 is properly closed.</li> <li>2. Check whether AC power supply cables of the fire extinguishing host are reliably connected.</li> </ol>
		The fire controller indicates that the ZONE circuit is faulty	Check the temperature and smoke sensing circuits based on the fire extinguishing wiring diagram, and check whether the corresponding 470Ω and 6.8K resistors are correctly connected.
6	DC switchgear failure	The power indicator is not on.	<ol style="list-style-type: none"> <li>1. Check whether the power circuit breaker MCB8 of the DC switchgear is closed properly</li> <li>2. Check whether the POW IN port on the DC switchgear is inserted properly</li> <li>3. Check whether the QF switch on the front panel of the DC switchgear is properly closed</li> <li>4. Contact ZOE after-sales service <a href="mailto:service@zoeess.com">service@zoeess.com</a></li> </ol>
		The WARNING indicator is not on	<ol style="list-style-type: none"> <li>1. Use the GS web terminal to check the battery status</li> <li>2. Check what fault alarms exist for the current RACK</li> </ol>

## 12 AFTER-SALES SERVICE

Shanghai ZOE Energy Storage Technology Co., Ltd. provides customers with a full range of technical support and after-sales service. Users can gain services by dialing our service number.

Please refer to the contract for the free warranty service information.

The following circumstances are not within the scope of our free warranty service:

- System damage or failure caused by not following the user manual.
- Damage or failure caused by not following the relevant electrical safety specifications for wiring and power supply or caused by poor site environment.
- System damage or failure caused by users' private modification.
- System damage or failure is caused by irresistible natural factors, such as typhoons, earthquakes, floods, fire, or harsh environments (high temperature, low temperature, high humidity, acid rain, etc.).
- After the failure occurs, the user fails to maintain the initial failure state, fails to timely notify the manufacturer, and handles without authorization, thus causing it to be unable to make a practical fault identification of the failure.



## 13 CONTACT

If you have technical issues with our products, please contact us. The following data is required to provide you with the necessary assistance:

- Product model number
- Serial number
- Fault information
- A detailed description of the problem

### **China**

Shanghai ZOE Energy Storage Technology Co., Ltd.

ADD: Building 2, e-Tong World Huaxin Park,

No. 1777 Hualong Road, Qingpu District, Shanghai, 201705

Email: [service@zoeess.com](mailto:service@zoeess.com)

---